



# MITSUBISHI ELECTRIC

## PROGRAMMABLE LOGIC CONTROLLERS

### FX PLC & GOT1000

*Changes for the Better*



# Pure Control

Compact PLC Applications

FX  
GRAPHIC OPERATION TERMINAL  
GOT1000



Mitsubishi Electric Corporation Himeji Works is a factory certified for ISO14001 (standards for environmental management systems) and ISO9001(standards for quality assurance management systems)



# Empowering Industries

# A World of



WOOD CUTTING NG



BAKING NG



WATER INDUSTRY NG



SUN TRACKING NG



TEXTILE INDUSTRY NG

## Understanding

A PLC is essentially at the center of control for every application, therefore it is vital that the chosen PLC meets the needs and requirements of the system - ultimately giving satisfaction to the end user.

The FX Family is designed so that the PLC CPU acts as a platform to which you can add and customize to your needs, allowing customers to create solutions that fit perfectly within their systems.

With a wide range of PLC base units that form the FX Family range, customers can select products that answer their applications and cost requirements with few compromises. The FX family contains several independent yet compatible series, five of which are the FX1S, FX1N, FX3G, FX3U and FX3UC - all of which have been designed with 4 key principles in mind:

- *Speed with Precision*
- *Flexible Design*
- *Backward & Forward Compatibility*
- *Low cost*

## Visualization

Efficient data management is a key component to achieving successful human machine interaction. The GOT1000 range of HMIs has been specifically built to enable customers to design interface screens that visualize the application in the easiest way possible. The intuitive GOT software and setup utilities allow customers to create easy-to-use screens and reduce setup time.



MATERIAL HANDLING NG



SHIPPING NG

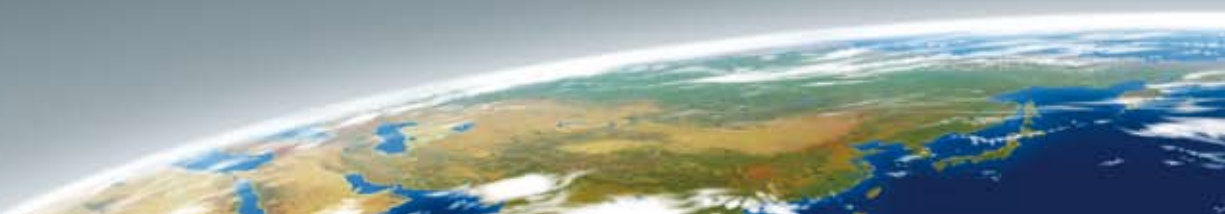

# Applications

## Customer Confidence

The FX Family is the PLC of choice across the world's industries and applications. At Mitsubishi Electric we pride ourselves on our close working relationship with our customers. By listening to customer needs Mitsubishi Electric has learnt to understand the requirements of modern applications and has developed PLC solutions that offer quality, reliability and a product that customers want. The success of this approach has been reflected in the sales of our products – now surpassing the 8 million milestone.

Furthermore with RoHS compliance as standard for the complete product range, customers are assured that the purchasing of FX and GOT products falls in line with the directives placed within the market, providing a more environmentally friendly control system.

## International Recognition and Reliability

Mitsubishi Electric has a reputation for producing high quality products. This comes in part from our commitment to understanding and meeting the requirements of international standards and directives.

In today's world of manufacturing, customers require durable products that can cope with the day in day out tasks of the application they control. To ensure our high levels of product reliability, Mitsubishi Electric's quality control program leaves nothing to chance, resulting in an undisputable quality that customers can rely on.



IN INJECTION MOLDING



LA LABEL PRINTING



PA PACKAGING

## CONTENTS -

Wood - Plank cutting	4
Food – Heating conveyor	6
Water Industry – Trickle filter	8
Photovoltaic – Sun Tracking	10
Textile Industry – Cold Drawing Nylon	12
Material handling – Distribution system	14
Shipping – Dehumidification system	16
Plastics – Injection molding	18
Printing – Label Printer	20
Packaging	22
FX & GOT Product Overview	24

# Wood Cutting Industry

## – Plank Cutting Application

### Features:

- FX1s – A robust Micro-PLC
- Simple Connection Analog Expansion Boards
- GT1020 touch screen Micro-HMI with Multi-connection functionality

### Application Overview:

Wood is a commodity that is being used every day around the globe. To handle the different types of needs for this material, the applications are many and range in complexity. For the smaller applications where customers require an affordable robust PLC, the FX1s often is the controller of choice.

#### **FX1s – A Robust Micro-PLC**

For effective woodcutting of different sized planks within the application, the FX1s PLC is equipped with two inverters. Control of the first inverter is responsible for positioning the plank so that smaller plank sizes can be created and the second inverter is used to drive the spinning saw across the plank.

The method used to control both the position of the plank and the saw blade axis is known as the Limit Switch Method. To provide control

of movements within the system two switches are provided in places where a moving part passes. For example, when considering drive control of the plank there are two points where these switches are located:

*- At the backboard, which determines the length of the plank to be cut. (To change the length of the plank being cut, the backboard can be manually adjusted to the user's requirement)*

*- At the loading position where new planks are placed on to the application.*

Once the first limit switch has been activated, the motor speed is reduced. On activation of the second limit switch, the motor turns off and the brake turns on to stop the movement of the plank. For requirements where greater precision is required the user can reduce the operation speed of the inverters to reduce overshoot of the second limit switch.

Although this method does not

provide the accuracy as associated with servo control, using inverters and the limit switch method, the application control system can be realized at a much lower cost.

#### **Analog Expansion Boards**

The FX1s can be fitted with an Analog to Digital or Digital to Analog expansion board on the front panel of the PLC. By using the FX1N-1DA-BD, the user has one analog output that can be used to control the speed of the cutting saw. Using a variable sinusoidal output into an inverter, the saw speed can easily be varied according to the size of the plank being cut.

Alternatively, for applications that require analog inputs, the FX1N-2AD-BD is available. This product permits 2 analog inputs to be integrated to the PLC which is particularly useful for when acquiring data such as speed or

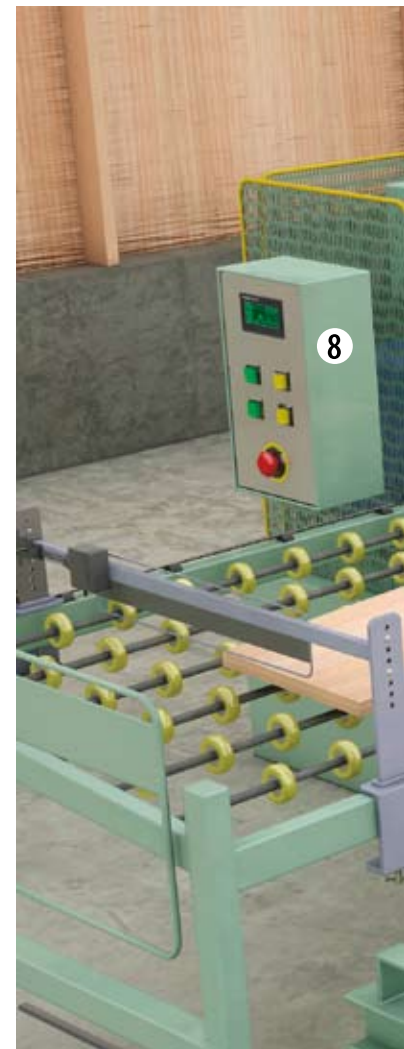

pressure that is to be used internally within the application.

#### **GT1020 - Just Right!**

Using the small but high resolution screen the GT1020 provides clear visualization of application data, as well as a touch screen interface. The 3-color LED screen (available in green, orange and red or white, pink, red) can be used to provide clear and easy to understand signals regarding the status of the machine, maximizing the potential of this micro-HMI.

For high performance cost ratio, the GT10 series also features multi-unit connection. This feature allows the applications to be enhanced with two HMIs, enabling the user to access application data from more than one place on the application. Thus when preparing the plank for cutting, the user benefits from a more ergonomically friendly application. Lastly, through the use of alternative

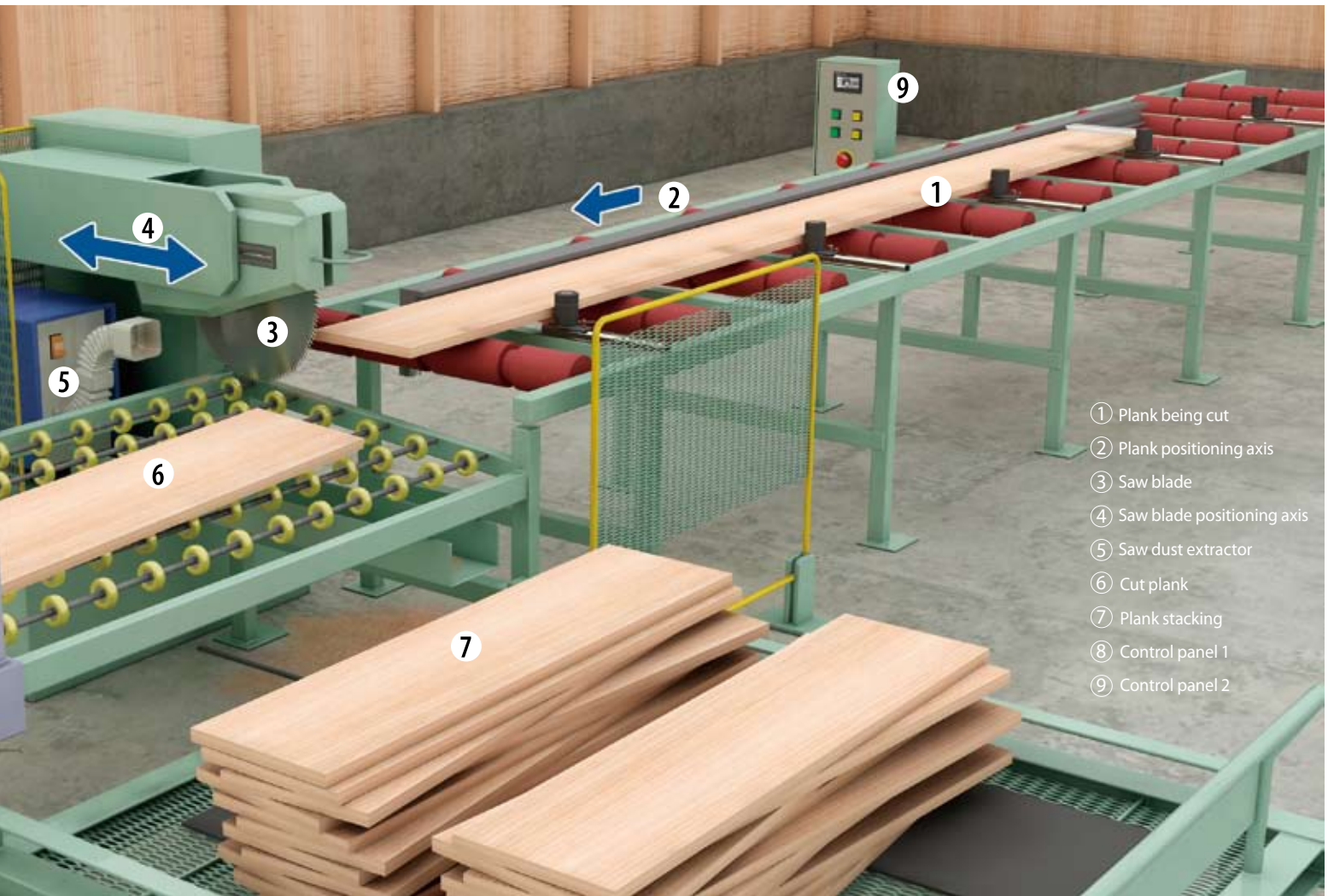

- ① Plank being cut
- ② Plank positioning axis
- ③ Saw blade
- ④ Saw blade positioning axis
- ⑤ Saw dust extractor
- ⑥ Cut plank
- ⑦ Plank stacking
- ⑧ Control panel 1
- ⑨ Control panel 2

start-up screens during start-up of the GOT, machine builders can feature their own brand logos when the customer starts the application, giving a more personal touch to the end customer.

Furthermore with removable logos the customer can provide a more customized feel to their application.

### GT10-LDR – Simple Download/Upload

GT10-LDR – Simple Download/Upload  
 The GT10-LDR simplifies download and upload of data between the GT10 series and a computer. Using the inbuilt USB device and embedded flash memory of the GT10-LDR the user can communicate program and operating system data between the PC and GOT10 without the need for direct connection. Thus improving production speed as well as removes the need for a computer on the shop floor.

### System Configuration:

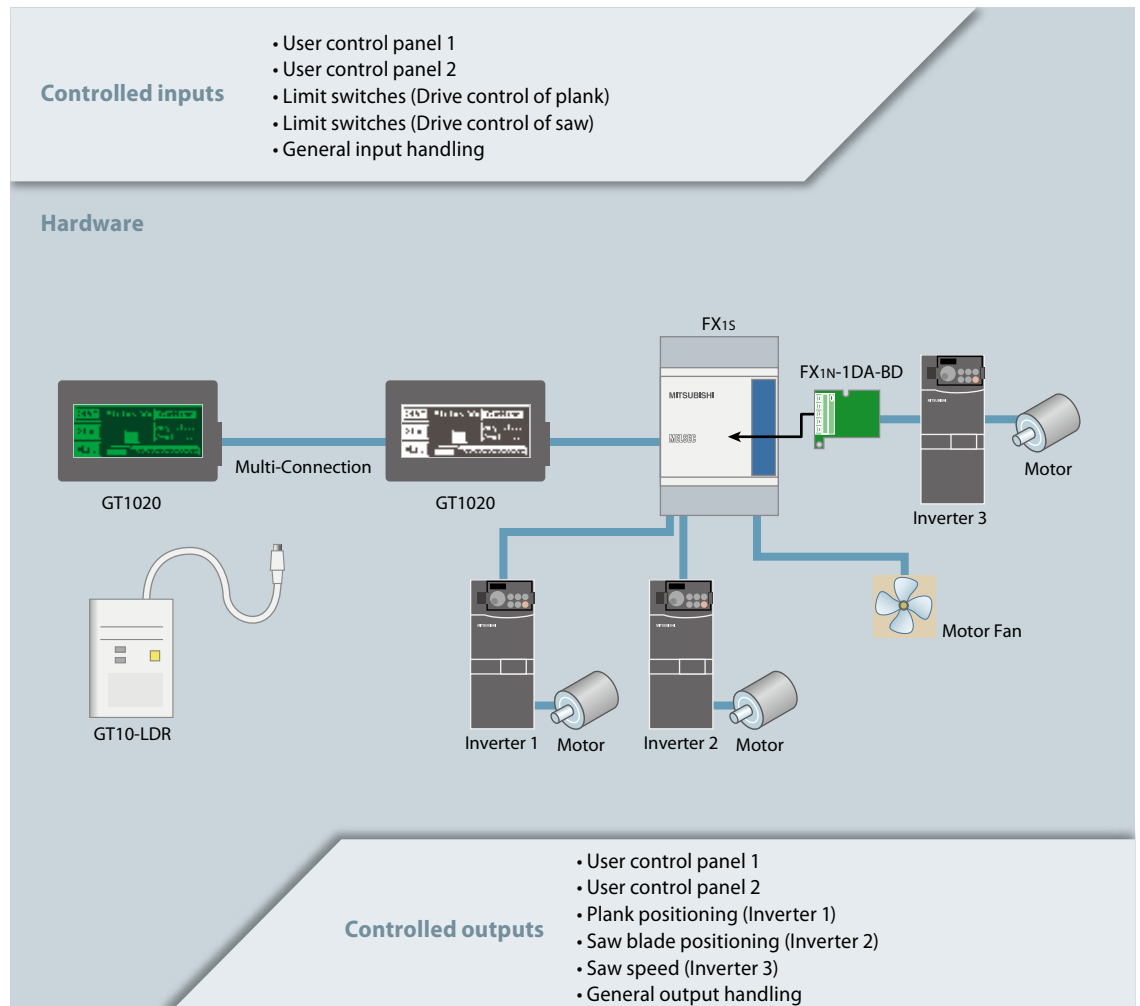

# Food Industry

## – Heating Conveyor Application

### Features:

- FX3G PLC - 3rd Generation General Use Expandable Controller
- Precise, simple, and compact FX3 series special adapters
- Battery-free Memory for Trouble-free Export
- Clear data representation via GT1030's 4.5 inch display

### Application Overview:

Food is a necessary part of our every day lives. To cope with the multitude of products that we take for granted, applications are continuously being modified and improved to sustain their competitive edge within the market.

#### **The FX3G - A 3rd Generation General Use Expandable Controller**

A heating conveyor is an application that can be typically seen within the food processing industries, however other connotations of the application are also applicable to industries such as the automotive, pharmaceutical and ceramic industries. The application is principally based on both analog controls with secondary requirements for positioning. To meet this demand, the FX3G steps to the forefront providing respectable processing speeds, control of up to 128 directly connected I/O, or up to 256 I/O with CC-Link remote I/O's (including remote I/O)

as well as a range of other attributes that make effective control possible. Memory storage is battery-less, being stored in EEPROM. This allows for great flexibility when exporting machines, as the data will be safely stored in the PLC for years on end. In addition to the built-in memory an optional memory cassette is available with loader functionality for easy program uploading and downloading.

#### **Effective Analog Control**

Within the conveyor oven, the challenge of providing optimized heater control is of the utmost importance. To achieve this successfully, the control system relies on both analog to digital control and digital to analog control. Using Mitsubishi Electric's range of analog Special Adapters the heating of the chamber can be tailored to the needs of the specified industry.

To provide the analog to digital control required for monitoring the

temperature of the furnace, the FX3U-4AD-PTW-ADP uses a 3-wire platinum resistance thermometer sensor (PT100) and a compensated range of -100 to + 600 °C (-148 to 1112 °F). With a resolution between 0.2 to 0.3°C (0.36 to 0.54 °F), the adapter can be setup to acquire precise data from even the most temperature sensitive applications.

To provide output control to the heaters, the system is fitted with an FX3U-4DA-ADP, which allows more than one heater to be controlled using the 4 outputs, permitting larger applications to feature different temperature zones. For plastic industry applications, different temperature zones may be useful for such processes as curing. The accuracy of the unit provides a resolution of either 2.5mV or 4µA as well as an adequate conversion time of 250ms with FX3G and 200ms with FX3U for all 4 channels.

The control system also makes use of an inverter connection that allows the

product being processed to be passed through the oven at various speeds via control of the conveyor belt.

#### **Speed and Simplicity - FX3 series special adapters**

The integrated PID function processes the input values from the adapter for closed-loop control meets even the toughest application requirements. FX3 series special adapters have dedicated data registers in the PLC where the data is automatically updated. This eliminates the need for writing data transfer commands into the PLC program, saving time and improving processing speed.

#### **GT1030 - Bright**

In today's food processing environment, it may not be acceptable to have applications that are dedicated to processing only one product. Applications need to be able to handle a range of products, while setup for changes should be kept to a minimum.



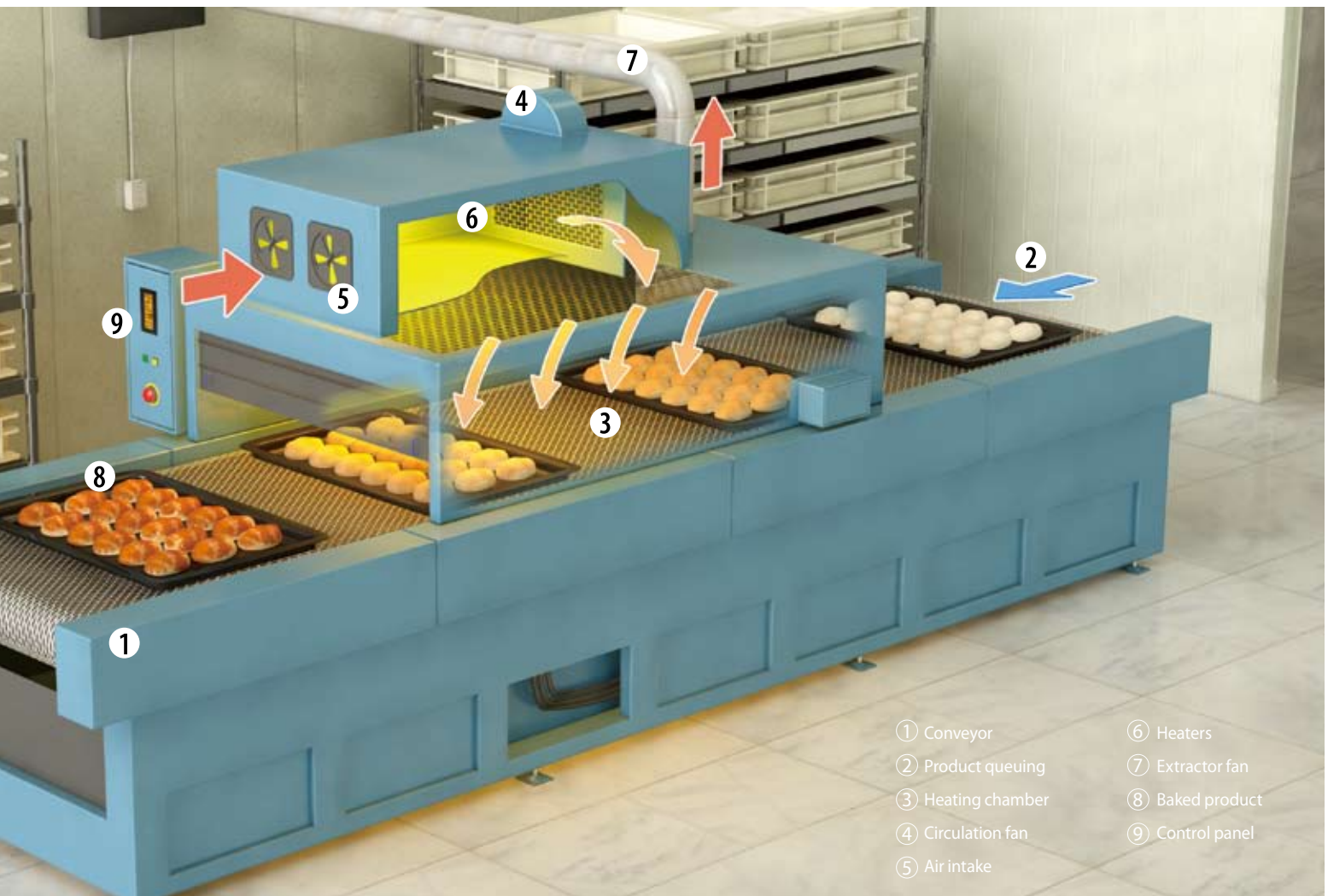

To achieve this, the GOT1000 features recipe handling, which allows the user to completely reconfigure the system's settings at a touch of a button.

The GT1030 is also equipped with a number of features that enhance the end-users interaction with the application. Using a 4.5 inch wide screen digital touch panel display, users are able to press two buttons simultaneously to activate critical tasks, reducing the chance of the wrong button being accidentally pressed. The GT1030 also features a real time clock, enabling the end user to automate oven on and off times from within the HMI.

The physical layout of the GT1030 is also versatile, allowing the user to vertically or horizontally mount the HMI to the application. This enables the optimal screen layout with respect to the application and versatility for space critical applications.

### System Configuration:

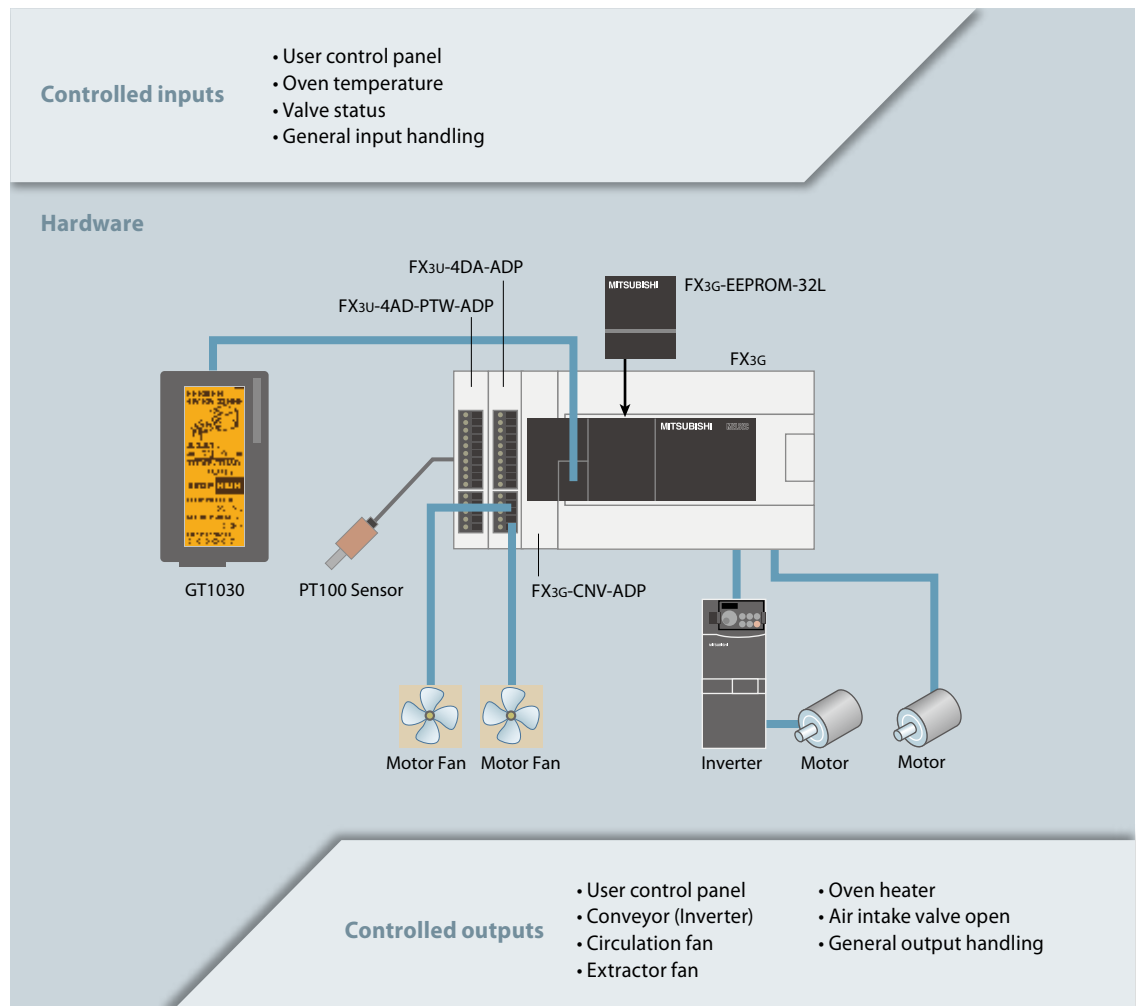

# Water Industry

## – Trickle Filter Application

### Features:

- Remote monitoring and maintenance via Ethernet communication
- FREQROL protocol for simple setup of inverters
- Energy saving inverters
- Handy HMI
- Data logging for comprehensive analysis

### Application Overview:

To sustain the health of the community, a crucial factor is to ensure that water treatment is correctly managed. To do this, a range of applications exist for large treatment plants that range from 1000s of I/O to compact PLC applications, like the trickle filter.

The trickle filter is a wastewater treatment system that biodegrades organic matter and can also be used to achieve nitrification. To do this a rotating distributor evenly distributes the wastewater from above the bed, where the wastewater trickles through a circular bed of coarse stones. The microorganisms in the wastewater attach themselves to the bed, which is covered with bacteria. This bacteria breaks down the organic waste and removes pollutants from the wastewater.

---

### Mitsubishi Electric Inverters

A key element to this application is providing a continuous flow of water through the tanks. For this task, Mitsubishi Electric's Inverters are the answer. A key advantage to using inverters is that they allow for energy saving via their variable torque load, enabling the system to increase power to the motors when increased pumping is required. For ease of setup, the inverters can easily be connected to the FX3U PLC using the FREQROL protocol. This protocol allows connection of an FX PLC and up to eight inverters communications in accordance with RS-485, and permits inverter monitoring as well as parameter reading/writing – all of which enables the customer to keep a sharp eye on events happening within the system.

---

### Ethernet - Remote Connection

With these types of applications often being located at remote sites,

it is no longer cost effective to have service personal frequently visiting the application just to perform routine checks. To overcome this problem, the control system features an Ethernet connection to enable remote monitoring and maintenance of the application. Remote access allows the user to setup control rooms where a number of different stations can be monitored from one location, all of which reduces labor costs and in-turn reduces the overhead costs of running the application.

To enhance remote monitoring, the FX3U Ethernet communication special function block connection also features E-mail, allowing the FX3U PLC to actively contact the user with status information and notify the operator in the event of an alarm within the application.

---

### A Mobile HMI for Mobile Users

For the occasional times when

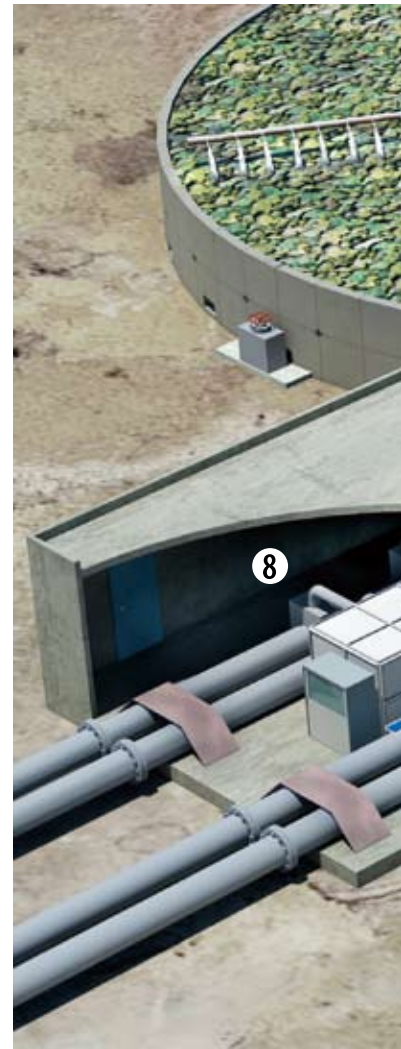

personnel visit the application in person, the cost of the control system can be reduced by removing the need for fixed HMI displays. The use of the GOT-Handy type terminal allows service personal to directly plug their mobile HMI into the system, providing a user interface that has been created especially for servicing the application, and helping maintenance staff to perform service in the most efficient manner possible.

Although technically based on the GT11 series, the GOT-Handy terminal also features a number of functions that ease operation in a mobile environment. Push-button switches with LEDs to display operation status are useful for controlling external equipment. The emergency stop switch allows the operator to immediately halt operation in case of an emergency. A selector key switch to provide access restrictions. The three-position grip switch (OFF-ON-OFF)



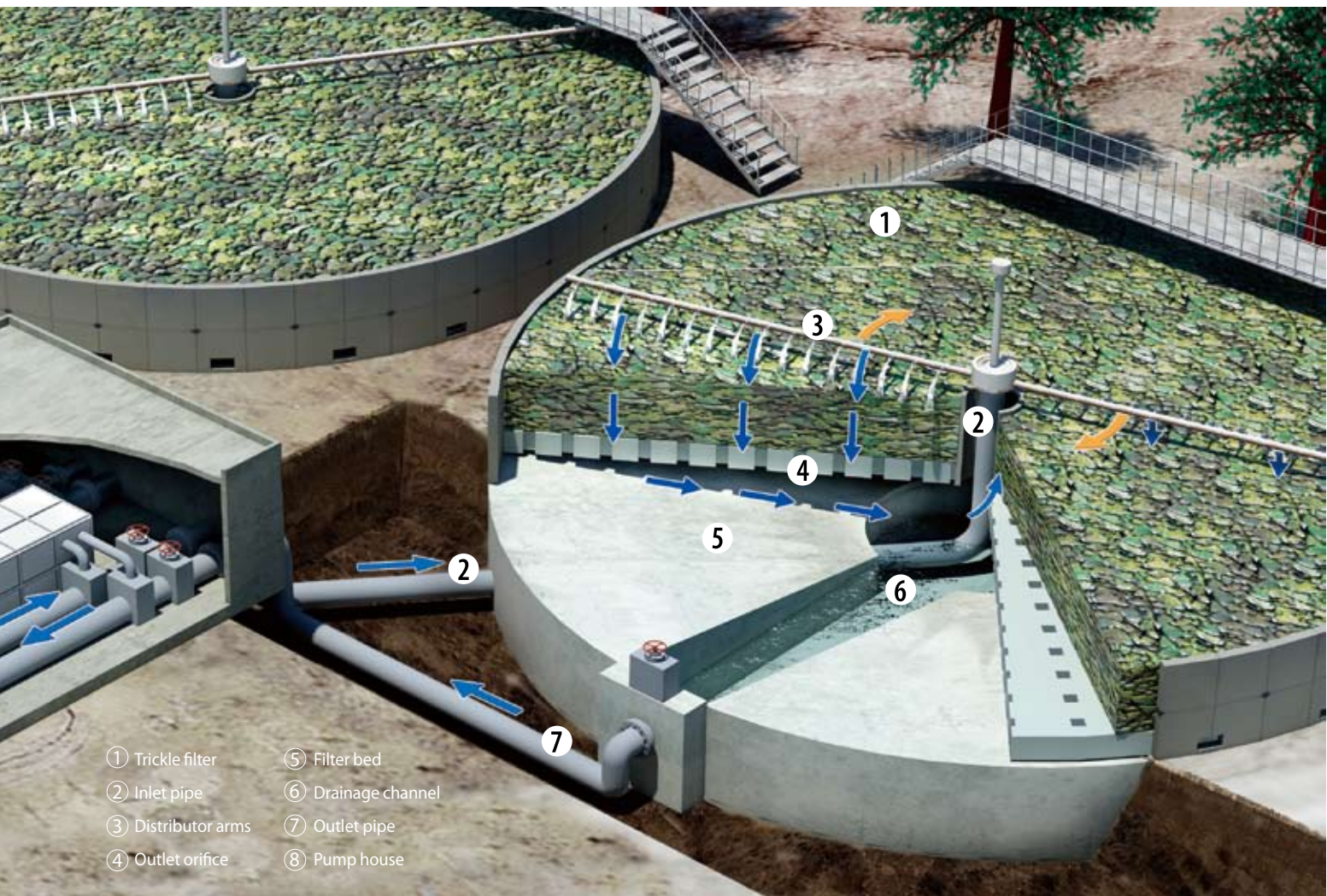

- ① Trickle filter
- ② Inlet pipe
- ③ Distributor arms
- ④ Outlet orifice
- ⑤ Filter bed
- ⑥ Drainage channel
- ⑦ Outlet pipe
- ⑧ Pump house

type 'dead-man' switch helps prevent errors and increases safety.

**Note:** Direct disconnection of the handy unit will cause the emergency stop switch to activate unless a design such as configuring an external parallel circuit is implemented. Refer to the GOT Handy manual for details.

### Analyze Data to Improve

#### Performance

The FX3U-CF-ADP special adapter adds data logging capability to the FX3U(C) PLC. Operational problems may not be noticeable until a history of performance can be analyzed. The timed storage of data allows the user to analyze trends and track problems. The FX3U-CF-ADP stores data in CSV format on MELCO approved CF cards up to 2 GB. With support of multiple files with user-defined names, automatic data timestamps, and easy read/write of data this adapter helps to bring out the best in whatever application it is installed in.

### System Configuration:

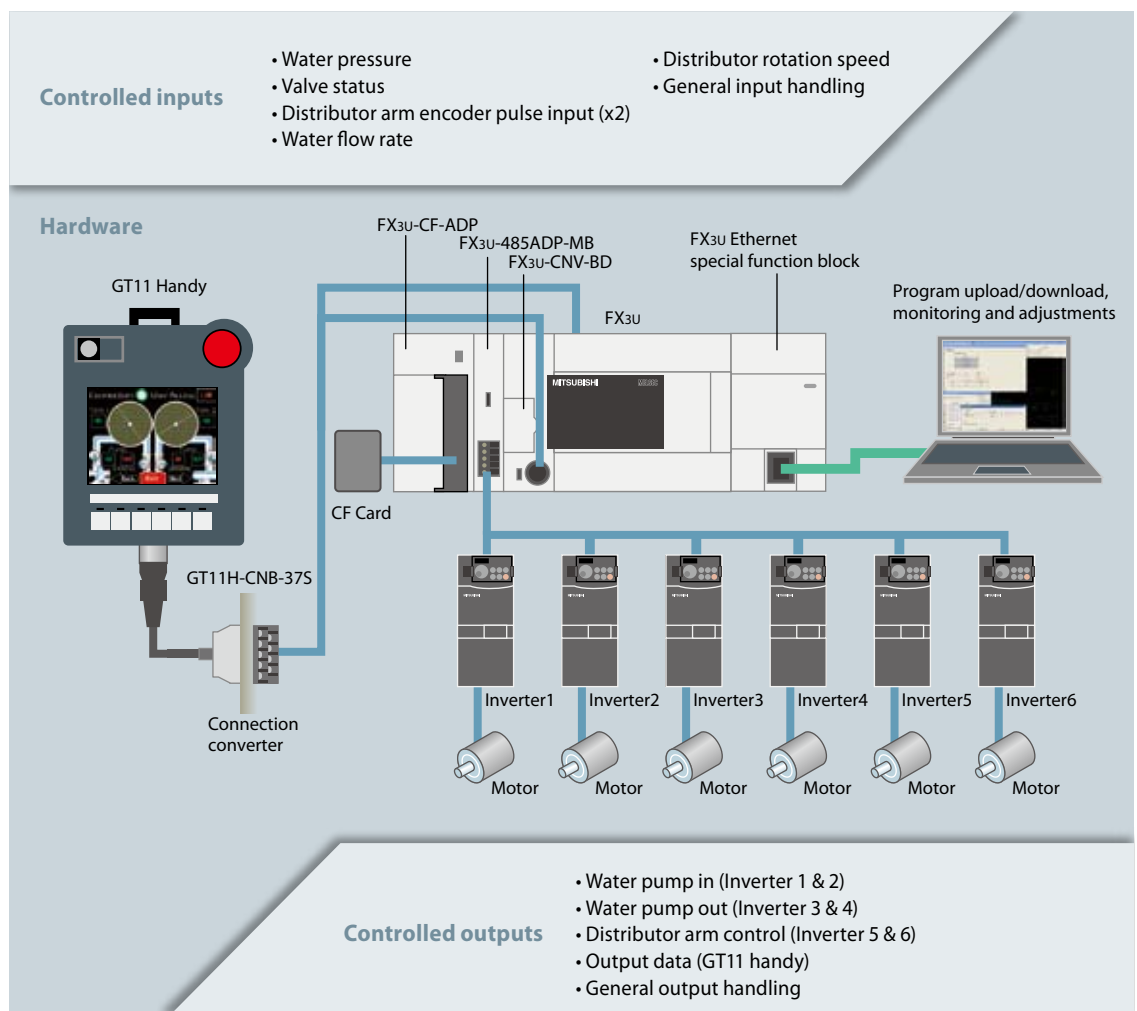

# Photovoltaic Industry

## – Sun Tracking Application

### Features:

- Remote monitoring and maintenance
- Reliable and uncomplicated serial communication
- Two-axis inverter control
- Low cost GOT solution



### Application Overview:

Renewable energy use is growing rapidly, and solar energy is one technology that is seeing great innovation to make it viable. Different technologies are available to transform solar energy into useable and transportable solar power, mostly by transforming it into electricity. The two most common ways are heat engines and photovoltaic systems (also called PV). Due to the ease of installation, growing efficiency and safe operation, PV panels are a popular option for supplying solar energy.

In conjunction with ongoing optimization of solar cells, optimizing the angle of the incoming light enables PV cells to attain their maximum efficiency. The most effective way to accomplish this is by rotating the flat solar panel about two axes: the zenith (horizontal axis) and the azimuth (vertical axis). Efficiency can

be improved by up to 20% in the winter and up to 50% in the summer compared to a fixed PV panel. To provide proper the necessary gradual daily panel movement a PLC can offer a simple, flexible solution.

#### **Complex Mathematic Functions**

To convert the time, date and PV position into the correct and precise zenith and azimuth angles, complex trigonometric functions are required. The FX3U has the processing ability to perform regular and inverse floating point sine, cosine, and tangent trigonometric operations as well as radian and degree conversion. This functionality allows the FX3U to do all necessary operations to calculate the optimal solar energy collection orientation of the photovoltaic panels.

#### **Serial Communication**

As system and maintenance costs are some of the most crucial factors when designing the control system

for PV panel, an intelligent mix of different PLCs helps mitigate costs while preserving functionality. This system incorporates a FX3U as the head station for receiving via an FX3U Ethernet device data from a remote PC for time synchronization, bad weather notification and maintenance. The connection between the FX3U and the local FX1s is implemented through the use of serial communication. The FX3U transfers the updated PV panel positions and checks if an error in any of the connected PLCs has occurred.

To employ serial communication the FX series provides the following serial communication formats between two or more PLCs:

N : N communication allows up to eight connected FX PLCs to automatically transfer data among the connected PLCs. In a network, data can be transferred among PLCs for devices specified in the refresh range, and those devices can be monitored by

every PLC.

Parallel link communication transfers up to 100 bit devices (M) and 10 data registers (D) between two PLCs of the same series.

Computer Link allows connection of up to sixteen FX PLCs to a personal computer for data transfer of directly specified devices in connected PLCs. This protocol is also available in FX documentation for connection to S/W produced in-house.

The most applicable protocol for this hybrid system is the N : N communication for a free mixture of FX series PLCs.

#### **GT10 series HMIs**

For maintenance and service the FX1s panel systems also incorporate a GT1030 5V HMI. This GOT does not require a separate cable to provide power, as it receives it from the programming port of the connected PLC reducing required cabinet size



- ① PV panel
- ② Zenith rotation
- ③ Azimuth rotation
- ④ Control panel

and cost. This small size GOT allows operators to monitor solar panel data and manually change the angle when panel maintenance is required.

The FX3U panel systems feature a GT1055 HMI, which like the GT1030 can be used for monitoring and maintenance, but is also capable of performing program changes. The bigger display allows it to display detailed information of all connected local PV panels to provide a quick overview of the system's operational status.

Arid areas ideal for solar panel farms face various environmental challenges from blowing dust and sudden, intense rainfall, among others. To ensure reliable operation the face of GT10 series HMIs all conform to IP67 for the highest level dust protection, an immersion level of water protection, and oil-proof protection.

### System Configuration:

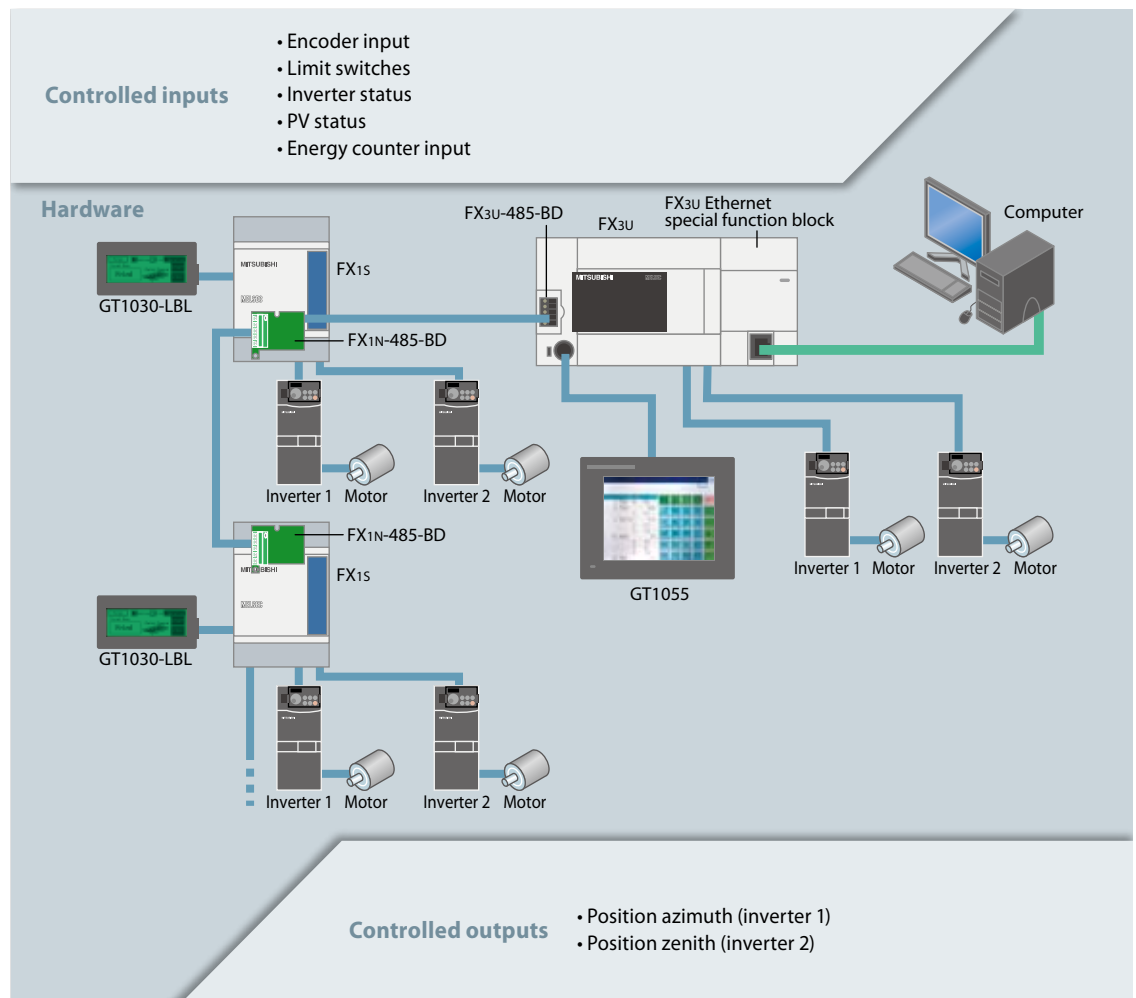

# Textile Industry

## – Cold Drawing Nylon Application

### Features:

- *FREQROL Protocol for simple setup of inverters*
- *Simple program change with Handy Programming panel*
- *Flexible Handy GOT*

### Application Overview:

Textile production is an important industry area whose existence is dependent on the speed and precision of machinery. Furthermore textile mills often operate 24 hours a day where high reliability of components and minimum application down time is a must.

Nylon is a material that has a multitude of uses, whether to make bearings for machines, fishing line, bristles in brushes, or bathing suits, the basic material properties are often the same. To provide this material for everyday uses, one important process in the production cycle is known as Cold Drawing. This process involves changing the nylon yarn with its randomly arranged filament into thread, stretching the material by up to 7 times its original length whilst increasing the elasticity of the fiber.

The cold-drawing process is achieved by unwinding the filament from one draw roller and winding it on to another where the winding rate is four or more times as fast as the unwinding rate. This difference in winding rate causes the yarn to be stretched.

#### **Mitsubishi Electric Inverters**

A key element to the application is controlling the speed at which the draw rollers turn in order that the yarn is stretched into thread. To do this Mitsubishi Electric's Inverters are connected to the spool and Draw Rollers and through use of the FREQROL protocol a host of inverter parameter settings can be setup and monitored directly from the PLC, simplifying setup and avoiding prolonged down time. Another advantage to specifying Mitsubishi Inverters is they feature variable torque load functionality, enabling the spool and roller speed to be maintained without the need for high torque

loading, thus improving the energy efficiency of the application.

All Mitsubishi Electric frequency inverters feature simple operation and optimized control and data management facilities. The integrated control terminals, the one-touch digital dial and the multi-language control panel provide instant access to current drive status and clear error message displays.

Furthermore, Mitsubishi Electric inverters feature connections to other standard networks like Modbus and CC-Link. Serial RS-422 and RS-485 interfaces and the optional USB port enable quick setup of multi-drop applications.

#### **Powerful portable programming panel**

It is an avoidable inconvenience to have a PC installed at the worksite or to bring a PC to the location just to perform basic data transfer or maintenance. The FX-30P HPP (Handy Programming Panel) is the convenient



alternative.

The FX-30P can store up to 15 programs (or up to 7 when the program size is above 32k steps) to give the flexibility of taking one HPP to perform multiple maintenance operations.

Sometimes it may be necessary to make changes to the PLC program or monitor the operation. The FX-30P allows not only monitoring, but also online program changes with the easy-to-use programming features built into the HPP. Improve speed and efficiency by using the FX-30P for parameter and program changes.

In many locations there may be a variety of PLCs in use, the FX-30P is FX family friendly, connectable to all FX PLCs.

Back at the office connection to a PC is easy with the FX-30P's built-in USB

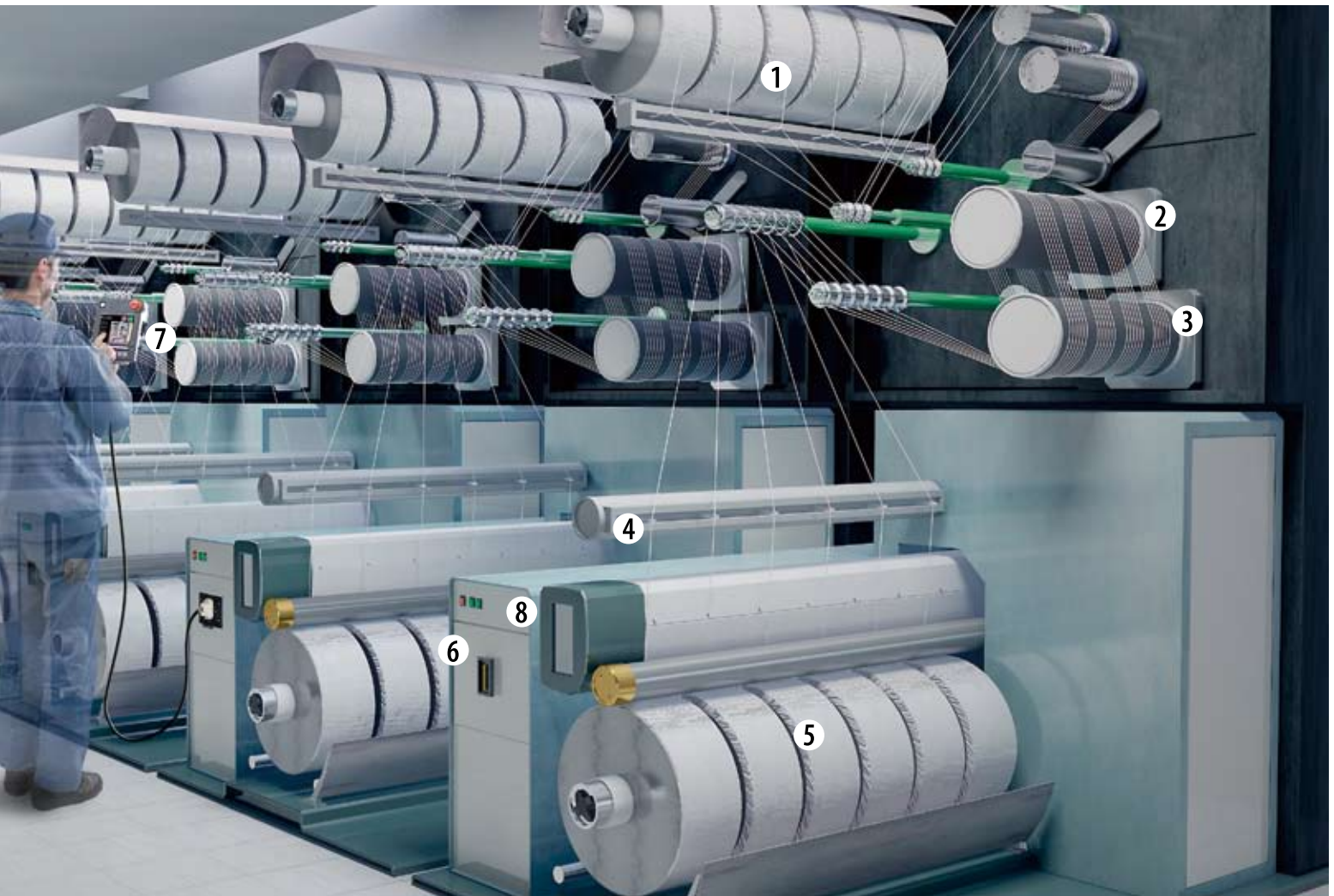

connector for simple and familiar connection. The dedicated software makes program transfer a breeze.

While back at the office it might be a good idea to check to see if there have been any FX-30P software updates. If so, updating the FX-30P is as simple as downloading the update file from the web, and then updating the FX-30P while it is connected to the PC. Staying up to date has never been easier.

### System Configuration:

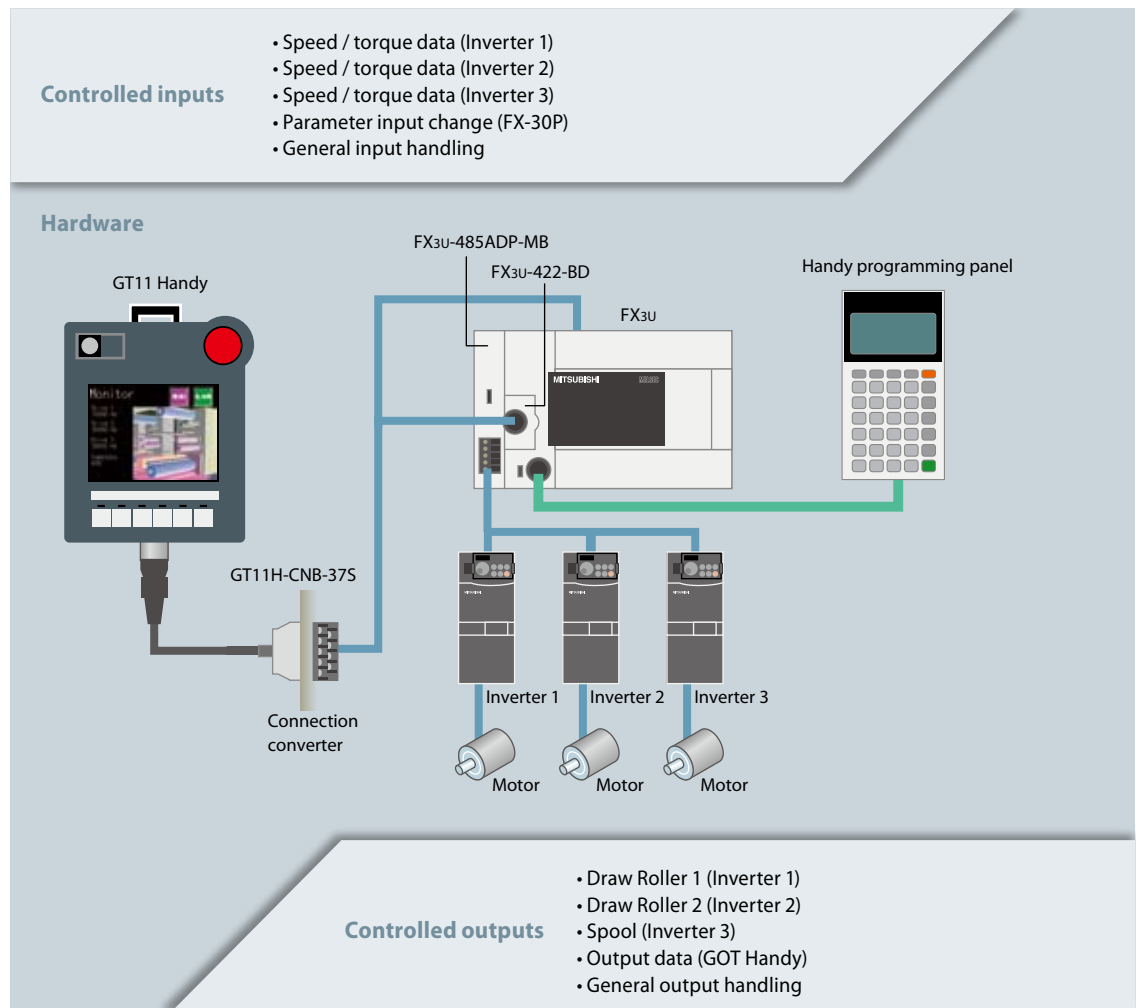

# Material Handling Industry

## – Package Distribution Application

### Features:

- Multi-network connection
- FX3U ADP Expansion Bus
- Easily expandable system
- Third-Party device Connection

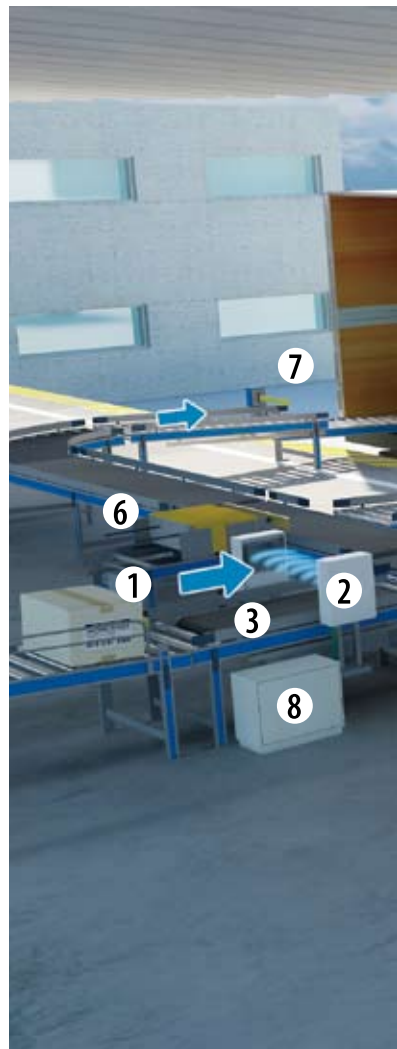

### Application Overview:

Reliable communication with a PLC is a necessity for every application – whether it is to provide a connection between actuators and switches, FX series products, or other third party devices. When communication types are appropriately selected they increase the effectiveness and efficiency with which the application completes its tasks.

#### Effective Data Management

Material handling is an industry area that defines its existence on effective data management. It is of the utmost importance that accurate information is continuously and reliably passed through the system, enabling database-updates and allowing the user to access information at any given moment. To meet these demands, the FX3U steps to the fore front, offering a range of serial and network communication options for

flexible easy to use communication functionality.

#### Straightforward Communication

Today package tracking is something that is vital within the material handling industry, allowing system users to see exactly where a specified package is at all times. To do this, the PLC is situated in the application as a handling device, passing information received from the RFID scanner up to the computer. An RFID scanner, a third party Modbus device, is also connected to the FX3U via an FX3U-485ADP-MB special adapter. Using Modbus communication, package location data from the RFID scanner can be quickly passed to the FX3U PLC.

Once data has arrived in the PLC, two processes are then initiated. The first is for the PLC to determine the destination target. This is carried out by using outputs of the FX3U PLC to provide control signals to the conveyor

system, thus creating a destination path for the package.

The second process is to update the main database with package data received by the PLC to set up this communication path the Computer link protocol is used. This allows all information received and sent by the FX3U to be recorded within the computer. Once in the computer, data can be easily managed and manipulated using third party software, allowing users with little experience to successfully interact with the activities of the application.

#### FX3U ADP Expansion Bus

A design feature of the FX3U is the new adapter expansion bus on the left hand side of base unit. Through this bus users can add additional analog and temperature units as well as multiple communications and positioning blocks. All control is carried out through direct access data registers

and setting bits within the base unit - allowing quicker set-up, easier use, and above all much higher processing speeds.

#### Expandability

Using the FX3U-485ADP-MB hardware connection, the Computer Link Protocol network is easily expanded, permitting up to 16 FX PLCs to be placed on the network up to 500m away from the computer. This flexibility offered by the FX3U allows users to expand their applications easily giving them the flexibility to operate within modern day businesses where change is constantly present.

The FX series also features a range of other serial networks that enable better realization of the application depending on the given requirements. These serial networks include N:N networking, Parallel Link and Modbus.

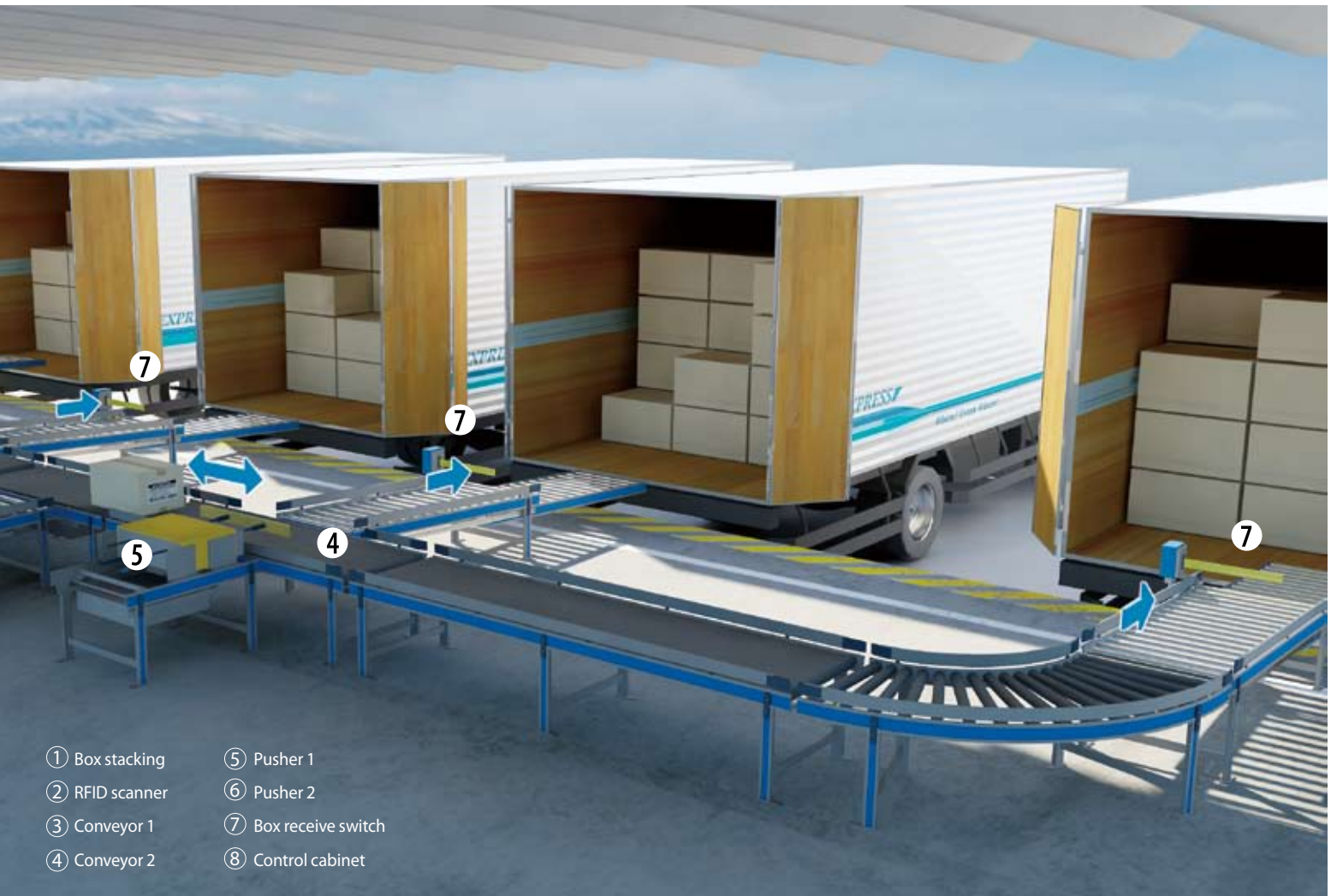

- ① Box stacking
- ② RFID scanner
- ③ Conveyor 1
- ④ Conveyor 2
- ⑤ Pusher 1
- ⑥ Pusher 2
- ⑦ Box receive switch
- ⑧ Control cabinet

To enhance serial network setup, Mitsubishi Electric's own PLC programming software, GX Developer, also features parameter windows that facilitate the setting up of networks. Through simple drop down menus, users can quickly and easily select the communication channel, the network type, communication speeds and time out periods, thus reducing the coding time for the programmer.

### Versatile Modbus connection

Modbus allows a simple connection of both FX3U PLCs and third party devices compatible with the protocol. This opens the customer to a range of new opportunities, ensuring that the optimum sensory devices and output devices are fitted to the control system. The FX3U-485ADP-MB hardware connection allows communication with up to 16 slaves with a transmission speed of up to 19.2kbps.

### System Configuration:

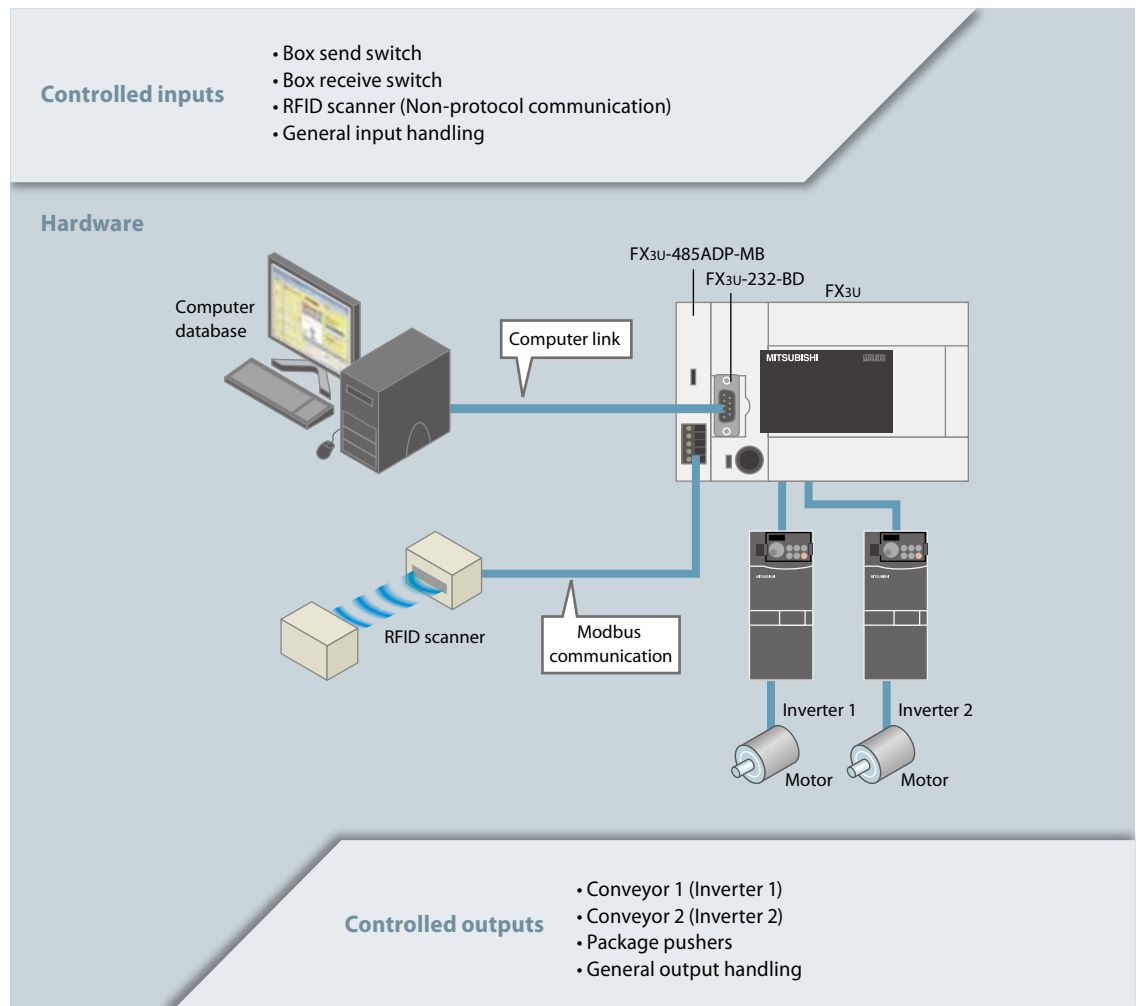

# Shipping Industry

## – Dehumidification Application

### Features:

- Shipping approvals
- Easy program change via EEPROM cassette
- High accuracy Analog Special Function Blocks
- Intuitive programming environment



### Application Overview:

Due to the nature of today's business, applications are produced for a variety of purposes and installed in a number of different environments. To create control systems for these applications, customers require products that are flexible as well as robust, so that they can operate in a variety of different environments without fear of stoppage.

#### International Approvals

Shipping is a large industry area that has evolved to handle one part of the transportation process. Within modern ships, be them cargo ships or cruise ships, there are a range of different applications where PLC control plays a vital part. However, before a PLC can be fitted to a ship certain legislative requirements must be first met. The FX series base unit range along with a range of SFBs, ADPs and other accessory products are compliant

with a number of key shipping approval organizations, including: Lloyds, German Lloyds, American Bureau of shipping, Registro Italiano Navale, DET Norse Veritas and Bureau Veritas. These approvals give the user confidence that the FX control system will operate safely within the bounds of this strict operating environment.

#### Adapting to the Application

To care for the condition of the ship and the products being transported, it is imperative that the ship interior is kept as dry as possible. Therefore, moist air, a catalyst for rusting and causing mildew, must be removed. This process of handling moist air within the ship is carried out by a dehumidifier application. The application itself is simple, taking air from the ship holds, passing it over a cooling filament, condensing the moisture from the air before then passing the dry air back into the ship hold.

To enable control of the application, the PLC is equipped with two analog units. The first unit, the FX2N-4AD, takes humidity measurements from the sensors located in the various hull compartments of the ship. These humidity measurements are used to alter the temperature of the cooling fins. The greater the humidity in the air the cooler the fins become. To provide accurate temperature output data, the fins are controlled by the second analog unit, the FX2N-4DA.

#### Direct Motor Connection

To remove condensed water from the system, the control system takes readings of the water levels from the condensed water collection tank. Once the threshold value is reached within the tank, the PLC turns on an output which is connected to a motor, and water is pumped from the collection tank until emptied. Once empty, the motor is shut down until next required.

#### Simple Program Change

In applications such as those fitted to ships, when a program change is required, often the personnel around the device are not familiar with the internal workings of the application and cannot program the desired change. To overcome this problem, an EEPROM cassette can be used by the application builder to store a modified program, after which it can then be sent to the end user. Upon receiving the EEPROM cassette, the end-user simply plugs the cassette into the PLC, where the EEPROM program will automatically run. This process minimizes complications and avoids the need for costly on-site visits for program changes.

#### Intuitive Programming Environment

For the machine builder who creates the PLC program for the application, the FX Family of controllers has a simple programming structure. Using GX Developer's straightforward



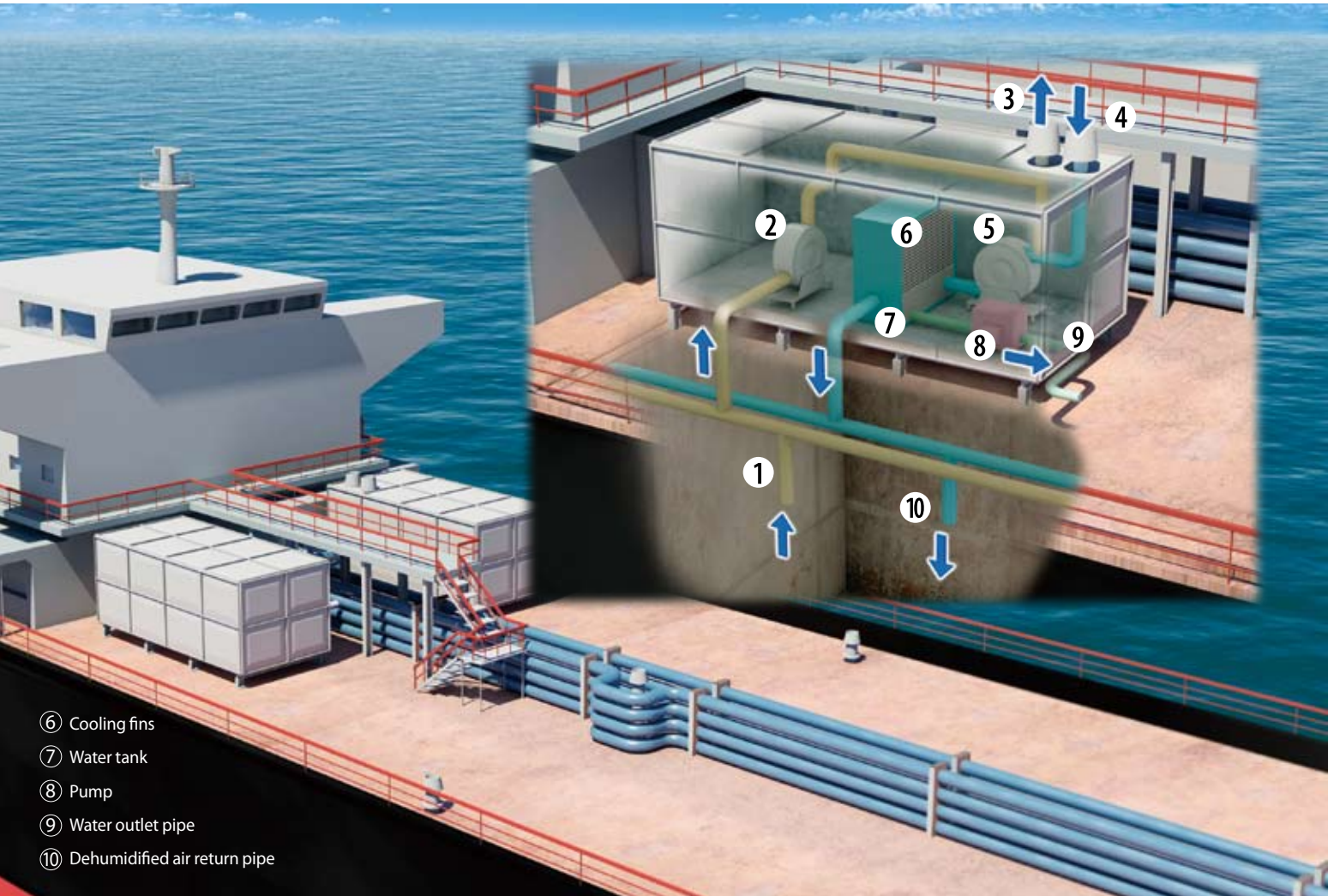

- ⑥ Cooling fins
- ⑦ Water tank
- ⑧ Pump
- ⑨ Water outlet pipe
- ⑩ Dehumidified air return pipe

programming environment, easy to use help functions, and advanced PC to PLC communication, machine builders can quickly develop programs that meet the demands of the application.

**System Configuration:**

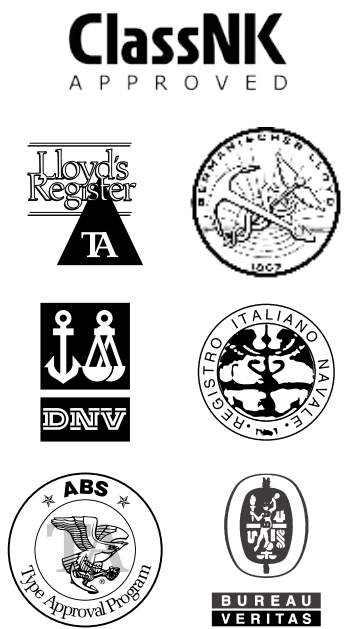
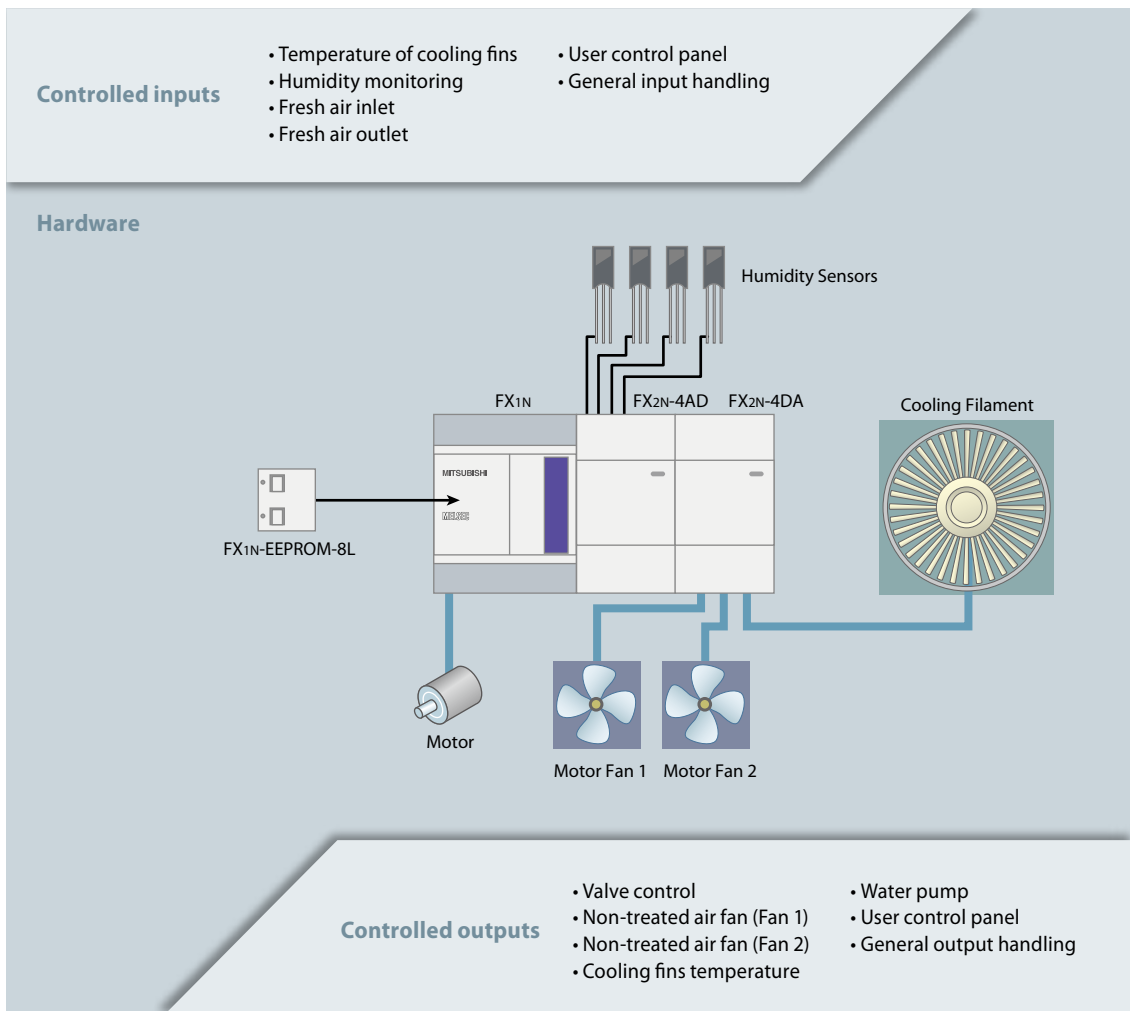

# Plastics Industry

## - Injection Molding Application

### Features:

- New FX3U ADP bus for high-speed precision control
- Third party device connection via Modbus
- High speed input/output ADPs with differential line drivers
- HMI with CF card interface and List Editor

### Application Overview:

In modern society plastics are something that most of us take for granted. The process of producing bottles, jars, toys etc. has become a refined process where speed and accuracy are two qualities that distinguish the good applications from the rest.

With injection molding applications, the process involves turning raw plastic granules into usable commodities. Although a straightforward process, the control system must handle analog and positioning procedures with high processing speed. To set a new benchmark within the compact PLC market, the FX3U was developed with a new high-speed Special Adapter (ADP) bus that implements control via direct access to data registers and bits within the PLC, capable of higher processing speeds for the customer's application.

#### High speed I/O Control

High speed I/O control is an integral part to the application. The application relies on control of the worm screw that drives the plastic granules down the heating chamber, control of the reciprocal injection mechanism that drives the melted plastic into the mold, and, once the plastic is set in the mold, control of the mechanism that opens the mold, ejects the plastic and re-closes the mold again. The high-speed input and output ADPs provide simple control of up to 4 axes that can process signals at up to 200kHz. Both the FX3U-4HSX-ADP and the FX3U-2HSY-ADP use differential line drivers which improve positioning accuracy and reduce the effect of noise within the system.

#### Specialized Temperature Control - FX3U-4LC

The new FX3U-4LC special function block allows for the ultimate level of temperature processing. With K, J, R,

S, E, T, B, N, PL II, WRe5-26, U, an L type thermocouple support as well as 3-wire platinum resistance thermometer sensor(s) Pt100, JPt100, Pt1000 and Voltage input available as well, the connection combinations of the 4 channels are vast indeed.

Temperature control via heating and cooling of the process allows the FX3U-4LC to handle all kind of applications. The built in PID auto-tuning functionality allows the module to optimize control operations with minimal operator effort.

#### Data Visualization and Storage

To enable the operator to successfully interact with the application, the control system is equipped with a GT1155 that provides sharp data representation via the 256-color display and 3MB storage space for screen designs. Among the many functions available, the GOT is equipped with extensive alarm handling as well as



- ① Hopper
- ② Worm screw

graph functionality that gives the user a range of options to select the best method to present application data. Screens can be tailored to the end user's needs so that high-level control is always one touch away.

CF cards are a useful accessory for transferring screen projects quickly, particularly when a large number of terminals need to be simultaneously updated. The CF cards can also be used to store alarm related information as well as other specified data, allowing service engineers to complete application analysis away from the application itself.

Mitsubishi Electric's data transfer tool also allows users to upload/download GOT project data from/to the HMI, without the expense of purchasing GT Designer 2.

#### Direct Program Change & System Monitor

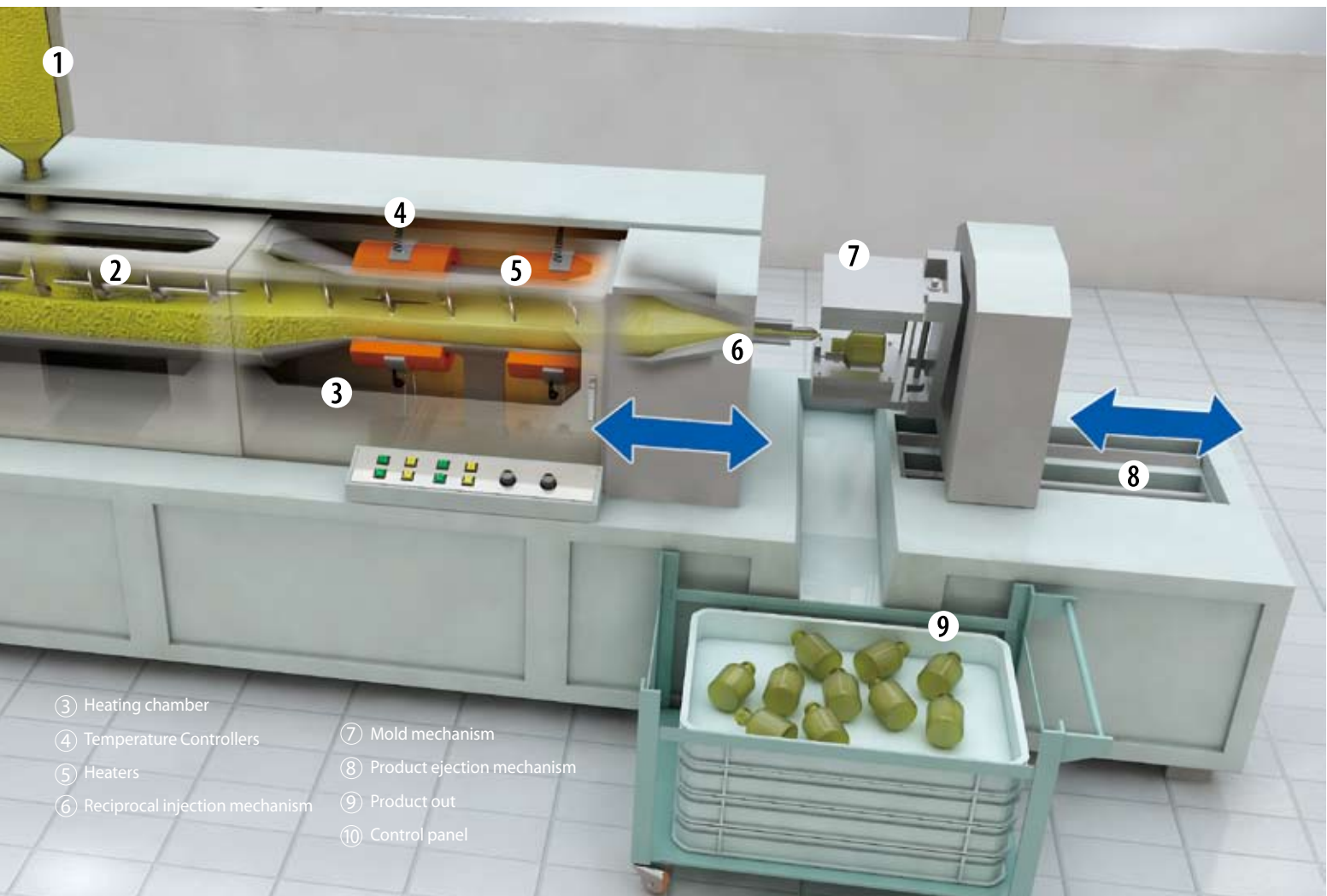

- ③ Heating chamber
- ④ Temperature Controllers
- ⑤ Heaters
- ⑥ Reciprocating injection mechanism
- ⑦ Mold mechanism
- ⑧ Product ejection mechanism
- ⑨ Product out
- ⑩ Control panel

Furthermore, included with the GT11 is a List Editor that provides a convenient method for minor on-site program changes in Mitsubishi Electric PLCs. Changes are carried out in instruction list format, removing the need for additional peripheral devices.

Using the System Monitor within the GT11, Mitsubishi Electric PLC devices can be monitored and changed. Monitoring can be performed by selecting individual devices to be monitored, or by specifying the first device in a range. Current values and set values of timer and counter devices can also be changed, along with the buffer memory of attached special function blocks.

### System Configuration:

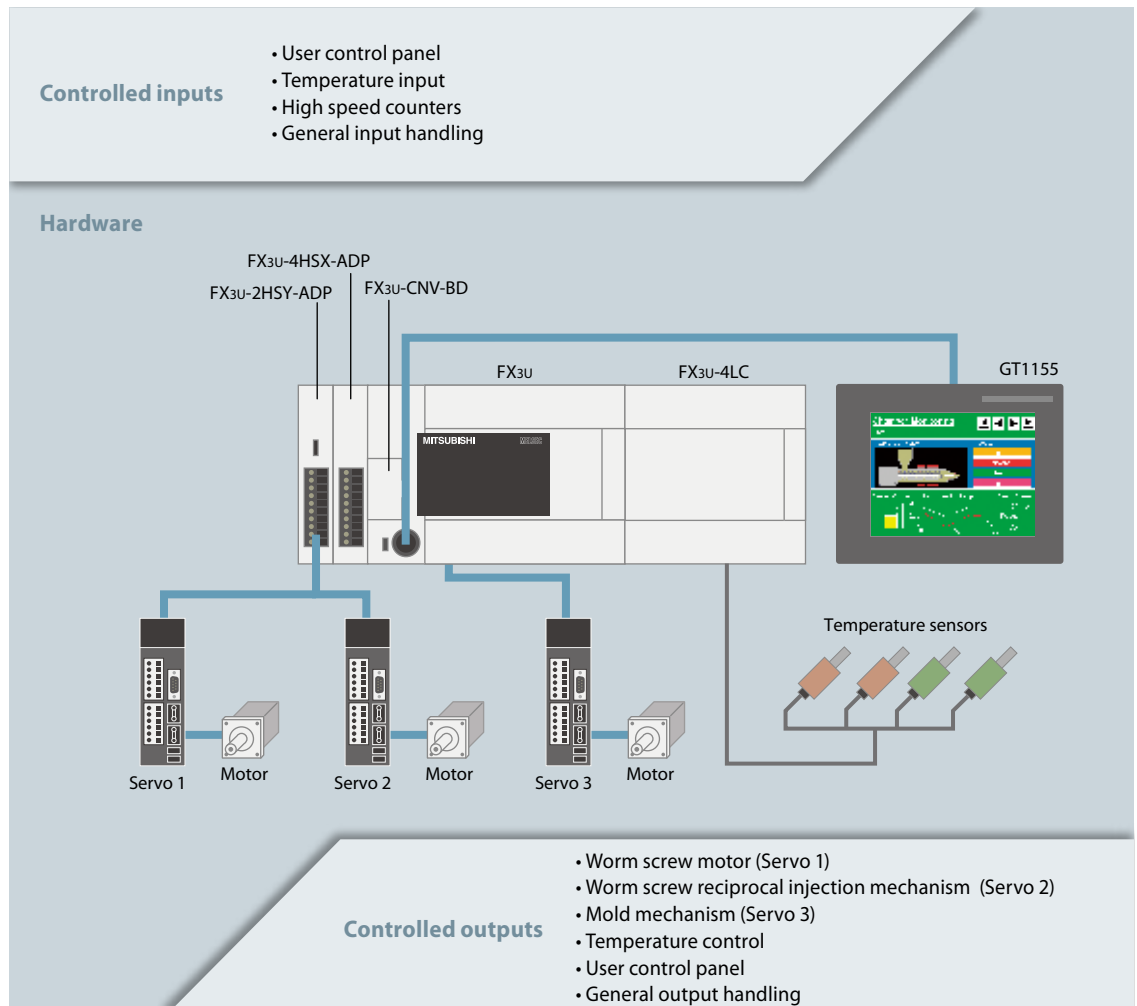

# Printing Industry

## – Label Printing Application

### Features:

- FX2N-10PG with up to 1MHz pulse output string
- Non-protocol communication for third party device connection
- GOT1000 Series HMI with language switching
- FX3UC - For space conscious applications

### Application Overview:

Printing is an industry where the FX range has always proven successful. Whether the customer seeks reliability, accuracy or speed, the FX range offers the correct attributes to give the customer's application a leading edge within the market.

#### Single-Axis Positioning Module

For the majority of applications the FX3U(C)'s built in high speed inputs and outputs offer sufficient control for the customer's application. However, in certain circumstances the user may wish to increase the positioning control performance. This can be carried out by simply connecting a FX2N-10PG Special Function Block, which provides a pulse train output of up to 1MHz. This highly accurate pulse output can be used to drive a single-axis stepping or servo motor enabling advanced control within the application. To limit the affect of noise within the system,

the FX2N-10PG is also equipped with a differential line driver. The differential line driver cancels out any white noise that may be present within the system, providing more precise positioning data to the drive train and thus more accurate printing results.

With special functions that include the selection of absolute or relative positioning and 7 different operation functions, such as jog mode, zeroing and speed increase or decrease functionality, the FX2N-10PG provides an array of options with which to control the application.

#### Control of third party devices

For control of third party devices, the FX range can also communicate via non-protocol communication, connecting to devices such as printers, barcode readers, etc. Using non-protocol communication, up to 4,096 data points can be sent and up to 4,096 data points can be received. And,

with a total extension distance of up to 15m via the FX3U-232-ADP-MB, this setup has potential for use with larger applications.

#### Speed with Precision

The FX3U(C) has the fastest processing speeds within the FX range, allowing basic instructions to be processed at 0.065µsec. For users this means faster program response and more accurate process performance as inputs, outputs and actions are processed and monitored more times per second.

Furthermore the FX3U(C) comes with a large standard internal memory of 64k steps. Larger memory allows the user to write larger and more complex programs as well as store more data in the file registers.

#### Overcoming the Language Barrier

For applications that are exported to different parts of the world, it is essential that the HMI language can

be reconfigured to end-users' native tongue. To do this, the GOT1000 series features easy language switching which allows a variety of spreadsheet based dialogs to be loaded within the user's program, permitting the user to switch the user language at a touch of a button. The GOT1000 series is compatible with Unicode 2.1 enabling a host of character sets to be chosen, whatever the language.

Using the GOT's ASCII input feature, new dialogs can be written within the HMI and sent to the PLC. This feature allows the user to modify the alphanumeric strings that are printed to the labels without complications of additional hardware or software.

With a range of fonts, graphical charts and alternative startup screens, the GOT1000 range allows the user to create a personalized interface to display in-depth information about the application. Also by using the available



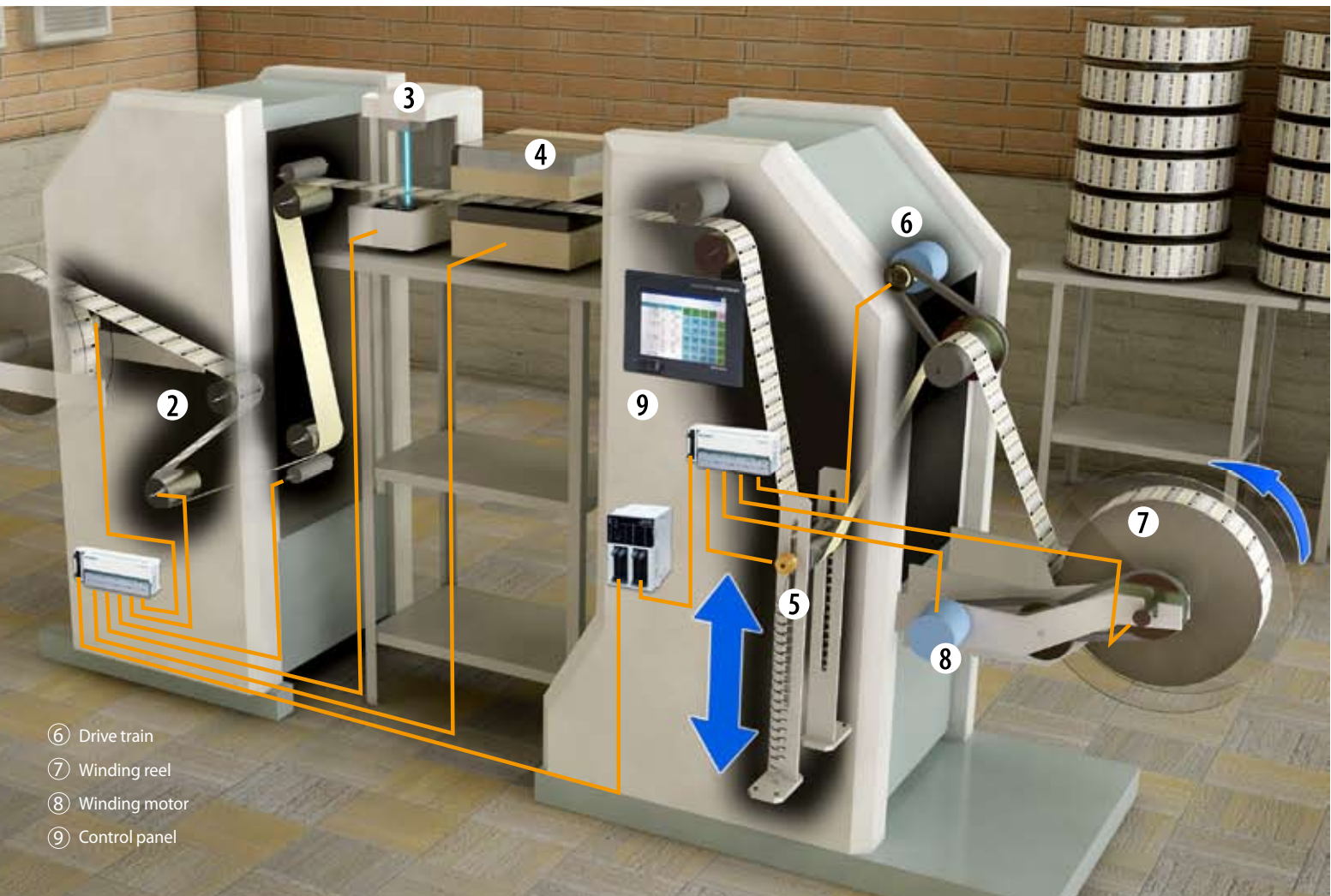

graphical tools, machine builders have a range of options from which to choose the most efficient method of representing data thus utilizing the maximum amount of available screen space.

Finally, with the front mounted USB port, service staff can quickly enter the PLC program, allowing the ladder code to be quickly monitored and changed as necessary. The USB "transparent mode" simplifies the connection setup, thus reducing down time of the application.

### Slim fit - FX3UC

To provide additional flexibility for applications where space is at a premium the FX3UC incorporates all of the processing power of the FX3U, but with a much smaller footprint. Additionally connector-type I/O make wiring more organized and easier to maintain. A necessity for small enclosures.

### System Configuration:

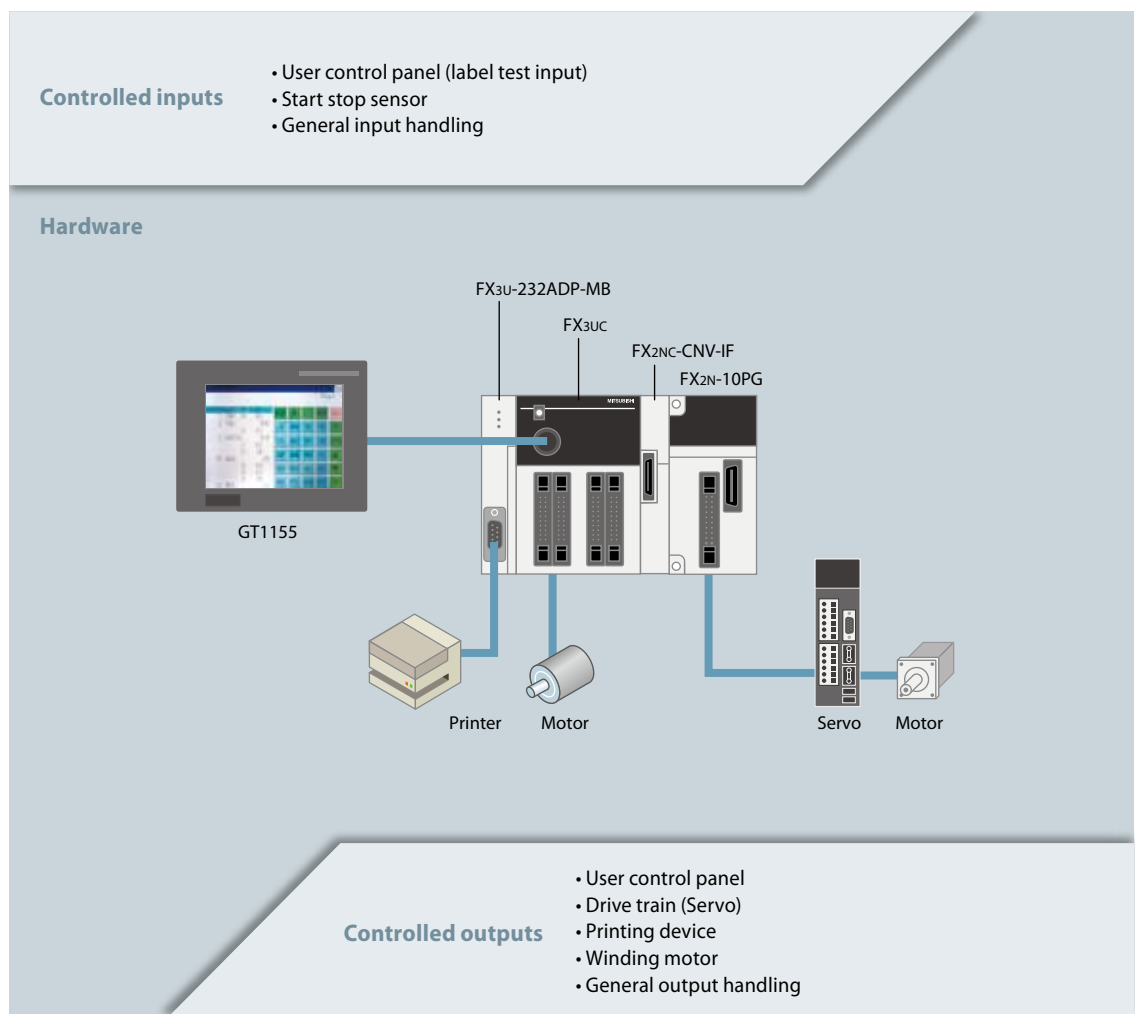

# Packaging Industry

## – Interconnected Applications

### Features:

- FX - Servo System Controller Network Advanced positioning control
- CC-Link connection - Effective data communication
- Backwards and Forwards Compatibility

### Application Overview:

Whether the product comes from the food industry, pharmaceutical industry or consumer goods industry, it is highly likely that the product undergoes some form of packaging during the production process. With a variety of packaging applications available, the PLC system must be flexible so that it can mold to the requirements of each solution. Whether it is filling, capping, sleeve placing, heat shrinking, or product placement, the PLC system must provide multifaceted control for every stage of the packaging process.

#### **Sustaining Pace with Technology**

To sustain pace with the technological improvements within the market and for customer's business' to stay competitive, it is important that control systems can be upgraded as the need arises. As new products feature in the market, it is unreasonable for customers to bear the cost of

upgrading their entire control system to accommodate new technologies. It is for this reason that the FX family of base units have been developed with backward - forward compatibility, allowing users to upgrade their base unit without the case of upgrading extension modules.

#### **SSCNET III - Servo System Controller Network**

Mitsubishi Electric's SSCNET fiber optic network provides new opportunities that were only previously available with advanced PLC platforms. The network is connected to the PLC via the FX3U-20SSC-H block that permits a host of new functionality at the compact PLC range. Features include torque control, that ensures the maximum torque is not exceeded when placing caps on jars, manual pulsar connection, enabling customers to quickly set up the position of the sleeve rolls, and dual axis control, realizing both linear and circulation interpolation for quicker

transition between points while reducing force loading on the product during positioning movements.

Another useful SSCNET feature is the Target Address Change function. Once the product is tested the PLC checks whether the jar is marked with a pass or fail status which can trigger the jar to be moved to a new target location. Using SSCNET, this process happens in one fluid movement – once the product status is identified the SSCNET module will automatically map the new path of the product without stopping, increasing the speed and efficiency of the process.

To enable flexibility when designing the application, SSCNET is equipped with fiber optic cables to convey control signals between the servo motors and the PLC unit. Fiber optic cabling means the servos can be placed up to 50m from each node on the network whilst providing a

communication speed of 50Mbps.

To simplify the setup procedure, the FX3U-20SSC-H also features its own programming software FX Configurator-FP. This software integrates with GX Developer and allows the users to set up positioning instructions in a table format enabling simple to advanced positioning control patterns to be quickly and easily created.

#### **CC-Link – Effective Data Communication**

FX applications often feature as part of a bigger application. In factory environments there may be many other processes happening simultaneously. To maintain synchronization and efficiency, application processes must be able to communicate with each other continuously. To do this, CC-Link has evolved, providing an open field bus and control network for communication with intelligent



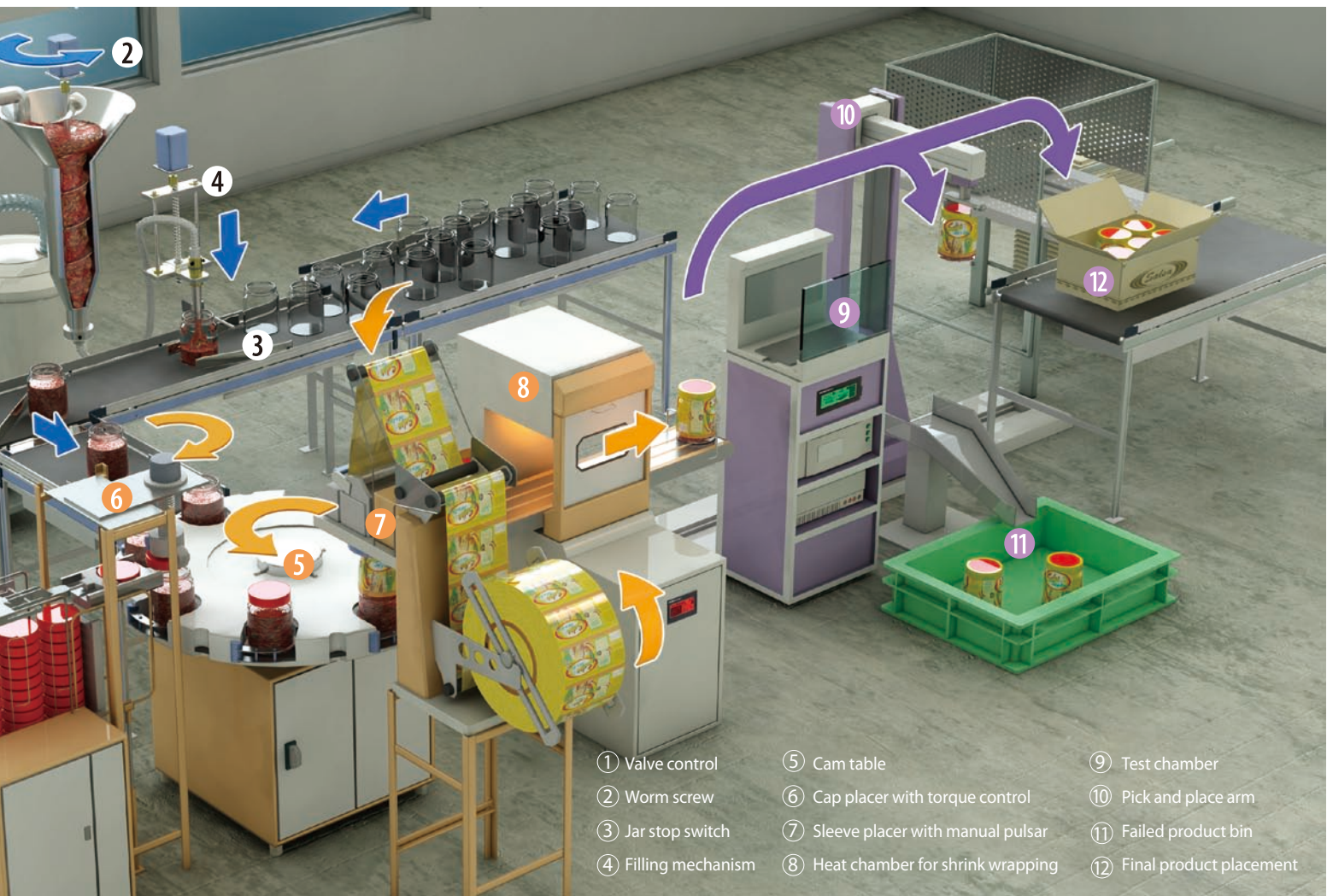

- ① Valve control
- ② Worm screw
- ③ Jar stop switch
- ④ Filling mechanism
- ⑤ Cam table
- ⑥ Cap placer with torque control
- ⑦ Sleeve placer with manual pulsar
- ⑧ Heat chamber for shrink wrapping
- ⑨ Test chamber
- ⑩ Pick and place arm
- ⑪ Failed product bin
- ⑫ Final product placement

devices such as display devices, bar code readers, and PLCs. With data communication via standardized twisted-pair cable, a maximum bus segmentation extension of 1,200m (at 156 kbit/s max.) and transfer rates of up to 10 Mbit/s (for reduced extensions), CC-Link provides a cost effective and versatile network for a range of applications. CC-Link is also connectable to a PC, allowing real time data exchange between the control system and the factory floor.

#### Extra flexible temperature ADPs

The FX3U temperature input ADP range has been extended to include FX3U-4AD-PNK-ADP, a 4 channel ADP for either PT1000 or Ni1000 thermometer sensors, and the FX3U-4AD-PTW-ADP, a 4 channel ADP for wider temperature range support for Pt100 sensors. The extended range allows greater flexibility for hardware setup.

#### System Configuration 1:

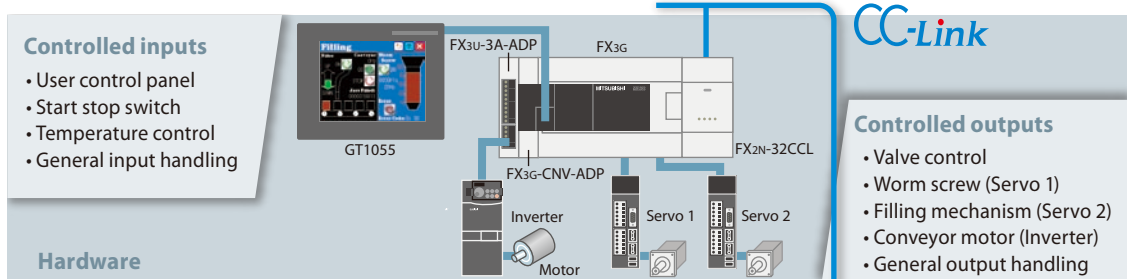

#### System Configuration 2:

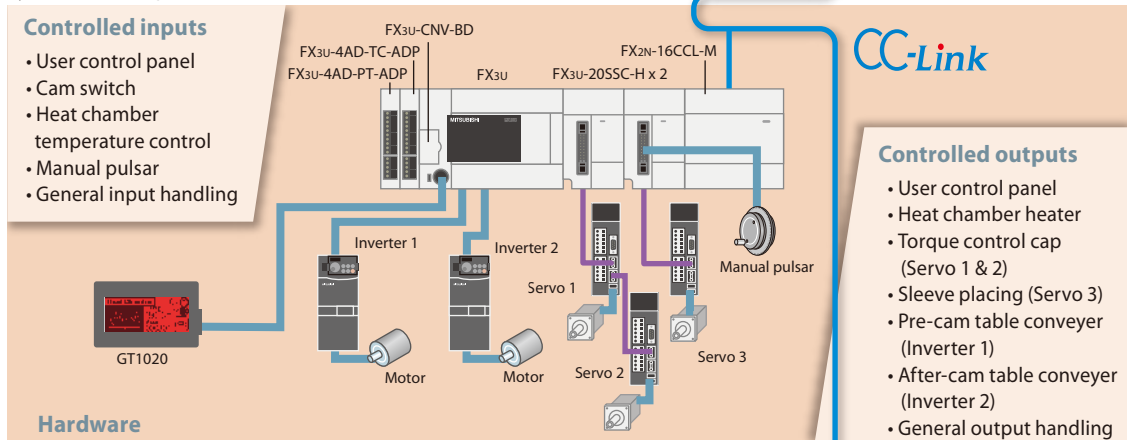

#### System Configuration 3:

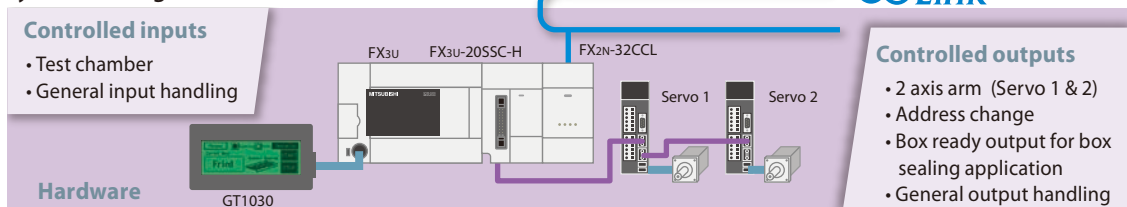

# Hardware



## Hardware

The setup of an FX system can range from a standalone base unit to more advanced systems with increased I/O handling, as well as analog and digital control. When creating FX control systems, the FX products fall into a set of defined categories.

### Base units

The unique range of base units makes FX PLCs suitable for a variety of applications. The range allows the customer to select the power supply, AC or DC, as well as the type and number of system inputs and outputs used on-board the system. All base units can be programmed with GX Developer programming software, allowing flexibility to transfer programs between different PLC types.\*1

\*1 Some instructions may not be supported in certain base units.

### Expansion boards

For small numbers of additional I/O (2 to 4), the extension adapter boards can be installed directly into the FX1S or FX1N controller. Interface adapter boards can also provide other communication interfaces for FX PLCs.

### Expansion I/O Blocks and Units

Both un-powered and powered expansion I/O can be added to the FX series PLCs. This allows customers to create systems that control the optimum amount of I/O to operate their application effectively.

### Special Function Blocks and Special Adapters

A wide variety of special function modules are available for the FX series PLCs, providing networking functionality, digital to analog control, analog to digital control, positioning control and temperature monitoring.

### Accessories

To enhance the FX System performance, the product range also features various memory cassettes, display modules and cables. This attention to detail allows customers to configure a system that can be fine tuned to meet the end customer's needs.

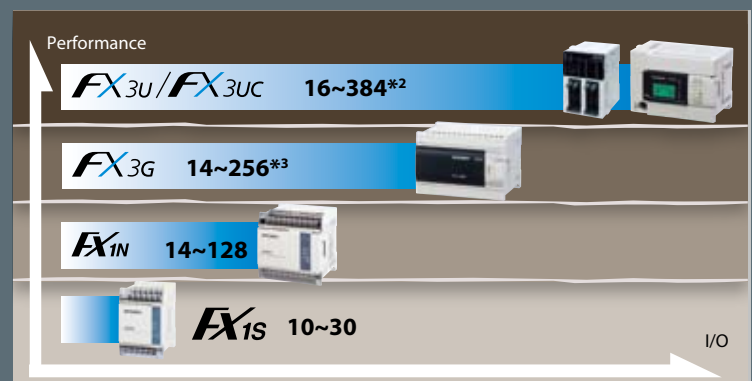

### FX1S

A micro controller for simple applications, supported by strong communication capabilities.

### FX3G

Advanced control, multiple communication possibilities and a wide range of options still make this PLC an industry leader.

### FX1N

This powerful micro brings the flexibility of the modular PLC design concept but, with the ease of use typical of FX series PLCs.

### FX3U/FX3UC

Ultra high speed, maximum performance and a simplified design concept make this the ultimate micro PLC.

## The right PLC for you

The FX family of PLCs is highly flexible, enabling fast and efficient configuration for the application at hand. It is the ideal choice regardless of whether you need a simple control system requiring up

to 34 I/O (FX1S), or a more complex system with up to 384\*2 I/Os (FX3U). Each PLC within the FX family has been created with a different application profile in mind.

Model	FX1S	FX1N	FX3G	FX3U/FX3UC
Power supply	100-240V AC, 24V DC	100-240V AC, 12-24V DC	100-240V AC, 24V DC	100-240V AC, 24V DC
Maximum I/O	30	128	256*3	384*2
Digital I/O	Relay/Transistor	Relay/Transistor	Relay/Transistor	Relay/Transistor
Cycle period/ logical instruction	0.55 µs	0.55 µs	0.21 µs	0.065 µs
PLC program memory	2k steps	8k steps	32k steps	64k steps

\*2 When networked with CC-Link (Discrete I/O maximum = 256)

\*3 When networked with CC-Link (Discrete I/O maximum = 128)



# Your System

## I/O Processing

Flexibility, speed, efficient configuration and ease of programming are often key features why customers choose FX products for their applications. The FX range is equipped with powerful processors that enable quick responses and accurate processing of tasks.

The FX base units' memory size range from 2K steps (FX1s) to 64K steps (FX3u). Larger memory means customers can write larger and more complex programs and store more data in data registers and extension registers.

The use of instructions within the FX PLC range is designed with one common concept: to make the building of applications and program writing easier and quicker, whilst reducing the chance of errors.

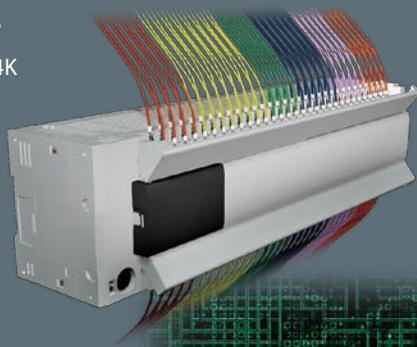

## Communication

The FX Family of PLCs are equipped to share a basic communication concept where additional RS-232, RS-422 or RS-485 communication boards can be added to the main base unit without increasing the required cabinet space. These can then be used for communication to various third party devices like

bar code readers, printers and modems. FX Family PLCs, such as the FX1N, FX3G and FX3U, also have a wider range of communications modules. These include options for connection to open and closed networks such as CC-Link, Modbus and Ethernet.

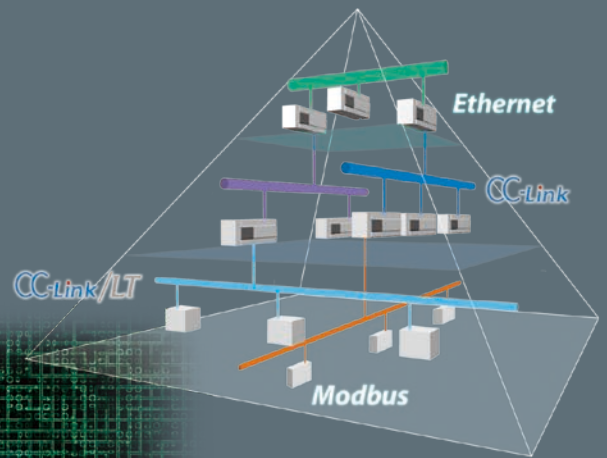

## CPU

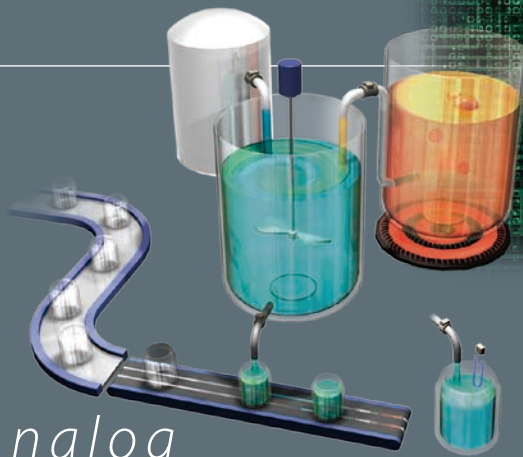

## Analog

### Standard Functions

From simple 1 to 2 channel BD boards to multi-channel analog input and output special function blocks, the level of analog control is customizable. Standard functions include analog input and output, temperature level input, and digital averaging of analog data to smooth out inconsistencies.

### Advanced Functions

Analog special function blocks add the advantages of having an embedded CPU to work independently of the PLC, improving response. Output patterns configured beforehand allow the analog signal to be output according to preplanned levels. PID control responds to changes with the most effective input helped by auto-tuning within the special function block. In the FX3U-4AD and FX3UC-4AD digital filtering can be implemented to reduce noise.

## Positioning

### Basic

Embedded high-speed outputs in all FX PLC main units allow user friendly positioning control via pulse trains. All positioning commands use axis parameters stored in special D registers to keep things simple.

### Advanced

Combining the FX3U/3UC with various pulse train output units lets them overcome even more advanced application challenges. Adding up to two pulse train output adapters to the FX3U doesn't even require a programming change versus using the integrated high-speed outputs.

### Ultra

The special function block for SSCNET III positioning allows a FX3 series PLC to connect via noise-resistant, high-speed fiber optic wiring to a MR-J3 series servo system. Manage the servos using the FX-Configurator FP software for real-time monitoring.

# Software



In today's world, programming software for PLCs is a forever evolving process. Customers place more focus on reusable program code and user friendly software. This helps to reduce errors, reduce programming time and helps manage the programming process.



## GX Developer

The key to any good software is that it is simple to use and intuitive. The GX Developer PLC programming package has achieved this by using a design that is simple to understand yet has access to powerful functions and tools. It also features help functions and an advanced communications setup utility, ensuring safe reliable data transfer to and from the target PLC.

GX Developer has also been designed so that it can interface directly with other FX programming packages, such as FX3U Positioning or FX3U Ethernet special function block setup software, allowing customers to access different programs in a straightforward manner.

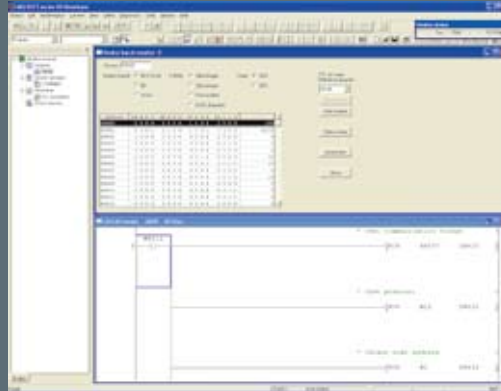

## GT Works 3

The all new GT Works3 is the most advanced screen design environment.

Experience the dawn of new era in visualization design to quickly transform the front end of your machine into a more user friendly and sophisticated interface you need a design environment that is both intuitive and efficient.

GT WORKS3 is the quintessential environment for visual design and configuration. User-oriented functions are integrated based on three main concepts - simplicity, definition and ease of use.

Screen development time is reduced up to 70% compared to other conventional HMI environments.\*

\* Compared to GT Designer 2 (based on our measurements)

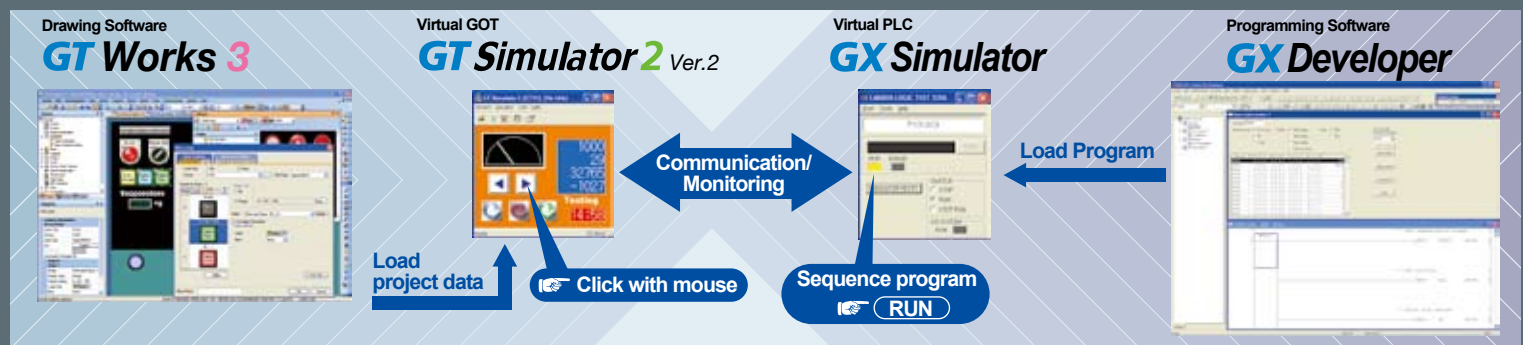
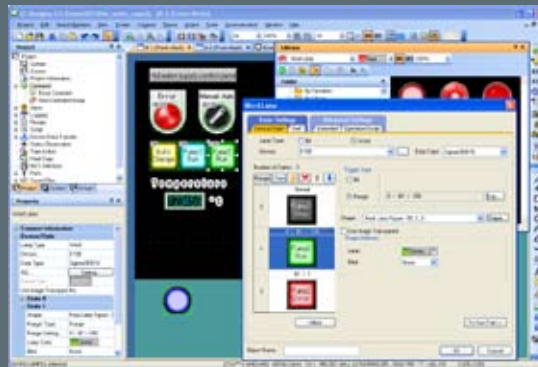

# Visualization

GRAPHIC OPERATION TERMINAL

# GOT1000

The consistent approach to data visualization!

Industrial control panels are increasingly turning into multifunctional human-machine interfaces. They are now an integrated part of modern automation systems, displaying detailed information on plant and machine control operations, connecting to higher-level management systems and providing a wealth of helpful and supportive functions for machine and factory operation, monitoring and diagnostics. The GOT1000 family features 3 different series to provide the best fit of functionality for all kind of user requirements from the GT10 series, achieving affordability with basic functionality, up to the GT16 series, the all-in-one model, packed with all the solutions to meet the needs of demanding customers.



## GOT1000 with FX Series PLCs

- Transparent Mode
- Back-up and Restore functionality with GT16
- List Editor (GT10/GT11 and GT16)
- Multi-Connection (GT10, GT11)
- No External Power Required (GT1020-L[L(W)] and GT1030-L[L(W)] 5V DC type)
- Common Software for ALL GOTs.

## GT16

Multimedia Video RGB Network Backup/restore Serial

Variety of integrated functions



15-inch XGA TFT  
GT1695M 65,536 color



12.1-inch SVGA TFT  
GT1685M 65,536 color



10.4-inch SVGA VGA TFT  
GT1675M 65,536 color



8.4-inch SVGA VGA TFT  
GT1665M 65,536 color



The GOT01-RS4-M is a multi-drop communication master unit for the GOT1000 series. Connected to the serial communication port of one PLC, it allows connection of up to 16 GOT1000 HMIs. The maximum total cable length of 500m allows HMIs to be placed at all locations where users require an interface to the machine, this provides more comfortable and safer machine usage even for larger machines. A free mix of connected GOT1000 terminals makes cost effective visualization are reality since only those GOTs with required functionality can be used.

## GT11

Hand health Scripting Parts movement System monitor

Standard functions for demanding users



5.7-inch QVGA TFT  
GT1155 256 color



QVGA STN  
GT1155 256 color



QVGA STN  
GT1150 16 gray scals



5.7-inch QVGA Handy GOT/STN  
GT1155HS 256 color  
GT1150HS 16 gray scals

## GT10

Multi language Multi action switch Recipe functions

Affordability with basic functionality



5.7-inch QVGA STN  
GT1055 256 color  
GT1050 16 blue scals



4.7-inch QVGA STN  
GT1045 256 color  
GT1040 16 blue scals

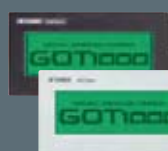

4.5-inch STN GT1030  
Monochrome Tricolor LED[Green/Orange/Red]  
[White/Pink/Red] BlackFrame / White Frame



3.7-inch STN GT1020  
Monochrome Tricolor LED[Green/Orange/Red]  
[White/Pink/Red] BlackFrame / White Frame



## Global Partner. Local Friend.

<b>Australia</b>	<b>Mitsubishi Electric Australia Pty. Ltd.</b> 348 Victoria Road, Rydalmere, N.S.W 2116, Australia Tel: +61-2-9684-7777 Fax: +61-2-9684-7245	<b>Indonesia</b>	<b>P.T. Autoteknindo SUMBER MAKMUR</b> Murara Karang Selatan, Block A/ Utara No.1 Kav. No.11 Kawasan Industri Pergudangan, Jakarta - Utara 14440, P.O. Box 5045 Jakarta, 11050 Indonesia Tel: +62-21-6630833 Fax: +62-21-66300832	<b>South Africa</b>	<b>Circuit Breaker Industries Ltd.</b> Private Bag 2016, ZA-1600 Isando, South Africa Tel: +27-11-92 8-2000 Fax: +27-11-392-2354
<b>Brazil</b>	<b>MELCO-TEC Rep. Com.e Assessoria Tecnica Ltda.</b> Rua Correia Dias, 184, Edifício Paraíso Trade Center-8 ander Paraíso, Sao Paulo, SP Brasil Tel: +55-11-5511-3146-2200 Fax: +55-11-5511-3146-2217	<b>Ireland</b>	<b>Mitsubishi Electric Europe B.V. Irish Branch</b> Westgate Business Park, Ballymount IRL-Dublin 24 Tel: + 353 1 / 4198800 Fax: + 353 1 / 4198890	<b>Spain</b>	<b>Mitsubishi Electric Europe B.V. Spanish Branch</b> Carretera de Rubi 76-80, E-08190 Sant Cugat del Valles, Barcelona, Spain Tel: +34-93-565-3131 Fax: +34-93-589-1579
<b>China</b>	<b>Mitsubishi Electric Automation (Shanghai) Ltd.</b> 17/F., ChuangXing Financial Center, No.288 West Nanjing Road, Shanghai, 200003, P.R.C Tel: +86 (21) 2322-3030 Fax: +86 (21) 2322-3000	<b>Italy</b>	<b>Mitsubishi Electric Europe B.V. Italian Branch</b> Centro Dir. Colleoni, Pal. Perseo-Ingr.2 Via Paracelso 12, I-20041 Agrate Brianza Milano, Italy Tel: +39-039-6053-1 Fax: +39-039-6053-312	<b>Taiwan</b>	<b>Setস্যু Enterprise Co., Ltd.</b> 6F No.105 Wu Kung 3rd RD, Wu-Ku Hsiang, Taipei Hsien, Taiwan Tel: +886-2-2299-2499 Fax: +886-2-2299-2509
<b>Czech</b>	<b>Mitsubishi Electric Europe B.V. - o.s. Czech Branch</b> Radlická 714/113a 158 00 Praha 5 Czech Republic Tel: +420 251 551 470 Fax: +420 251 551 471	<b>Korea</b>	<b>Mitsubishi Electric Autoomation Korea Co., Ltd.</b> 1480-6, Gayang-dong, Gangseo-ku Seoul 157 -200, Korea Tel: +82-2-3660-9552 Fax: +82-2-3664-8372	<b>Thailand</b>	<b>Mitsubishi Electric Automation (Thailand) Co., Ltd.</b> Bang-Chan Industrial Estate No.111 Moo 4, Serithai Rd, T.Kannayao, A.Kannayao, Bangkok 10230 Thailand Tel: +66-2-517-1326 Fax: +66-2-517-3239
<b>France</b>	<b>Mitsubishi Electric Europe B.V. French Branch</b> 25 , Boulevard des Bouvets, F-927 41 Nanterre Cedex, France Tel: +33-1-55 6855 68 Fax: +33-1-55 68 57 57	<b>Poland</b>	<b>Mitsubishi Electric Europe B.V. Polish Branch</b> ul. Krakowska 50 32-083 Balice, Poland Tel: +48 12 630 47 00 Fax: +48 12 630 47 01	<b>U.K.</b>	<b>Mitsubishi Electric Europe B.V. UK Branch</b> Travellers Lane, Hatfield, Hertfordshire., AL10 8XB, U.K. Tel: +44-1707-27 6100 Fax: +44-1707-27 8695
<b>Germany</b>	<b>Mitsubishi Electric Europe B.V. German Branch</b> Gothaer Strasse 8 D-40880 Ratingen, GERMANY Tel: +49-2102-486-0 Fax: +49-2102-486-1120	<b>Russia</b>	<b>Mitsubishi Electric Europe B.V.</b> Moscow Representative Office 52 /5, Kosmodamianskaya. nab., 115054, Moscow, Russia Tel: +7-812-633-3497 Fax: +8-812-633-3499	<b>U.S.A.</b>	<b>Mitsubishi Electric Automation, Inc.</b> 500 Corporate Woods Parkway, Vernon Hills, IL60061, U.S.A. Tel: +1-847-478-2100 Fax: +1-847-478-0327
<b>India</b>	<b>Messung Systems Pvt. Ltd.</b> Electronic Sadan NO:III Unit No15, M.I.D.C. Bhosari, Pune-411026, India Tel: +91-20-27 12-3130 Fax: +91-20-27 12-8108	<b>Singapore</b>	<b>Mitsubishi Electric Asia Pte, Ltd.</b> 307 Alexandra Road #05-01/02 Mitsubishi Electric Building, Singapore 1599 43 Tel: +65-6470-2460 Fax: +65-6476-7439		



### Safety Warning

To ensure proper use of the products listed in this catalog,  
please be sure to read the instruction manual prior to use.

 **MITSUBISHI ELECTRIC CORPORATION**

HEAD OFFICE: TOKYO BUILDING, 2-7-3 MARUNOUCHI, CHIYODA-KU, TOKYO 100-8310, JAPAN